

感谢您使用芝杜 zidoo 旗下产品，您可以关注我们的社交平台账号，
和我们一起交流与分享。

Thank you for choosing products of Zidoo. Friend us on
WeChat or Weibo to communicate and share with us.



微信公众号 @ zidoo
WeChat Official Account



微博账号 @ 芝杜官方
Weibo Account



Facebook @ zidoov



Twitter @ zidoov

如需更多帮助，请访问芝杜 zidoo 官网的用户论坛进行咨询。

If you need more assists, please visit user forum of the official
website of Zidoo for consultation.



官网网址 /Official website: www.zidoo.tv

目录 /Content

01

Z20 PRO 硬件介绍

设备接口	P1
硬盘装载	P3
设备连接	P4
性能参数	P6

02

开机初始化向导

P7

03

OTA 系统升级

P11

01

Introduction to Hardware of Z20 PRO

Device Interface	P15
Installation of Hard Disk	P17
Device Connection	P18
Specification	P20

02

Boot Initialization Wizard

P21

03

OTA System Update

P25

Z20 PRO 硬件介绍

设备接口

Zidoo Z20 PRO 配备有丰富的音视频输入输出接口及数据传输接口，请参考本手册内容。

1. 正面

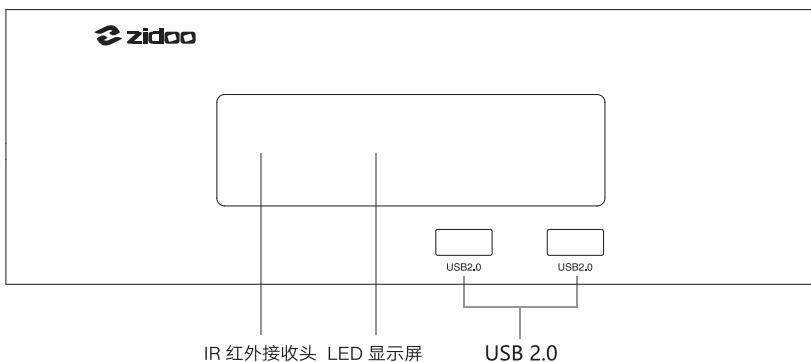

2. 右侧



3. 背面

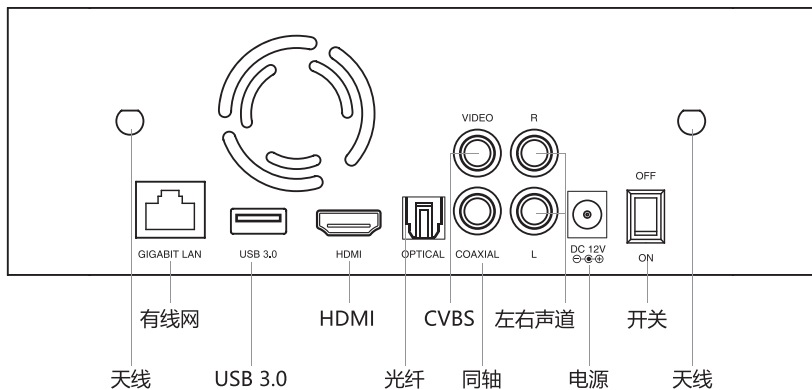

天线安装说明：请将附件中的两根天线安装至上图所示的天线接口。

注意：

- * 请在断电的状态下装载\更换硬盘，如是全新硬盘，请格式化后装载。
- * 请不要将任何东西遮挡散热风扇孔。
- * 请不要接触液体，以免流入设备内部造成损坏。
- * 非指定维修人员，请不要拆开机壳。

装载硬盘

Z20 PRO 搭载 3.5 寸硬盘仓, 内置 SATA 高速传输接口, 无需借助任何工具, 将硬盘 SATA 接口朝里轻松推入即可装载 (硬盘最大支持 14TB)。

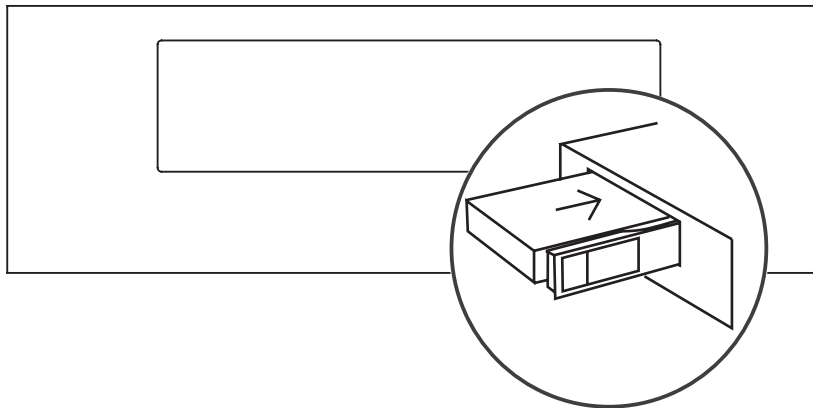

注意：请勿在设备通电的状态下装载或更换硬盘，以免造成设备或硬盘数据损坏，如果是全新硬盘，请先格式化硬盘再装载至设备，本机支持硬盘格式为 :EXT3,EXT4,NTFS,FAT32,EXFAT。

设备连接

1. HDMI 连接电视

- ① 将设备断电，请务必保证电视机与机顶盒都在断电的状态下操作。



- ② 在电视机断电的状态下将 HDMI 线一头插入设备的 HDMI 接口、一头插入电视 HDMI IN 接口。



- ③ 电源连接，本设备配备有 DC 电源适配器，请将 DC 适配器接头连接在本机的 DC 电源输入接口，将 DC 电源线的插头一端接入交流 110~240V 的电源插座。

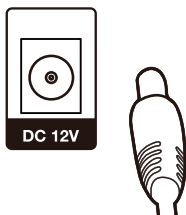

④ 电视选择对应的视频源。

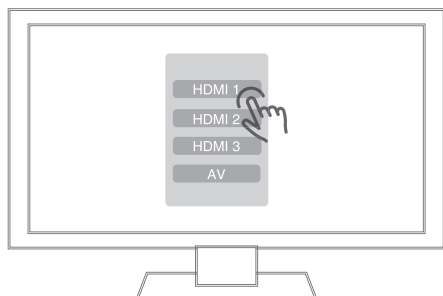

2. AV 线连接电视

连接方式同 HDMI 线的连接方式。

3. RS232 连接 3.5mm 插头连线顺序

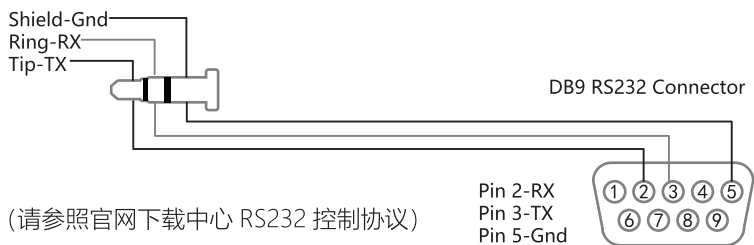

Z20 PRO 性能参数

前置显示	LED
机身	铝合金
系统	Android 11
CPU	Realtek RTD1619BPD ARM Cortex-A55(四核)
GPU	ARM Mali-G57
NPU	1.6TOPS
运行内存	4GB DDR4
内部储存	32GB eMMC
蓝牙	BT 5.2
Wifi 网络	2.4G+5G 双频 WiFi, 802.11 a/b/g/n/ac/ax 2T2R, 802.11ax MIMO OFDM
以太网网络	1*RJ-45 以太网 (10/100/1000Mbps)
HDMI 输出	HDMI 2.1, 最高支持 4K@60p, HDR, 12Bit, YCbCr 4:4:4 色域空间, 支持音频源码透传
HDMI 输入	HDMI 2.0, 支持 4K@60p, PCM 音频
视频解码	4K@60p, AV1/HEVC/H.265 12Bit HDR10, HDR10+, 杜比视界
音频解码	支持次世代高清音频源码直通, 解码立体声
智能控制	手机 APP 控制, RS-232, TCP/IP 控制 (支持网络唤醒)
SATA	1*HDD Bay
USB	1*USB 3.0, 2*USB 2.0
电源	DC 12V 2A
其他接口	1* 红外接收器, 1*RCA 视频, 1*RCA 左右声道 1* 同轴 /1*SPDIF 光纤 (2CH, 5.1CH), 1*3.5 (毫米) RS-232, 2* 外部高增益天线

开机初始化向导

正式使用机器前，系统将会为您进行第一次初始化设置。请根据实际设备搭配和使用需求来设置您的设备，以获得最佳的使用体验。

1. 系统语言选择、屏幕缩放、时区设置

按照您的语言习惯选择系统语言。



按遥控器左右方向键调节合适的屏幕显示大小。

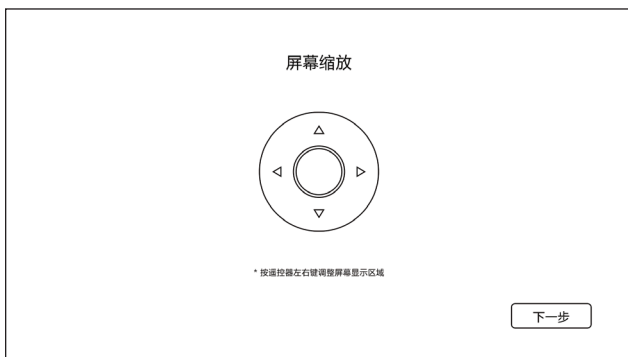

根据您所处地区选择对应系统显示的时区。

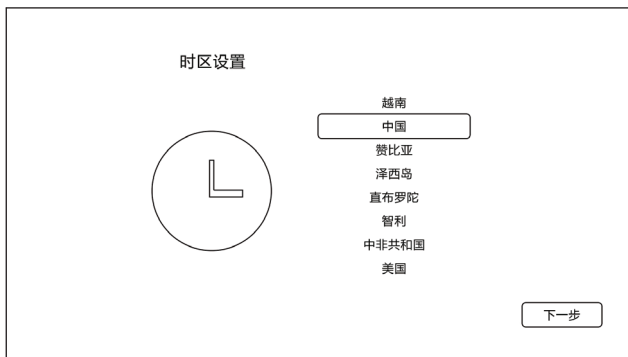

2. 网络设置

设置相关网络配置，让机器快速连接网络。



无线网络 (WIFI)：选择网络 SSID，输入密码，连接 WiFi。

有线网络：只需插入网线即可自动连接网络。

3.选择输出模式

请根据需要选择相应的模式来完成设备输出参数的设置。

向导模式：根据您的使用环境和设备连接情况选择对应的选项。

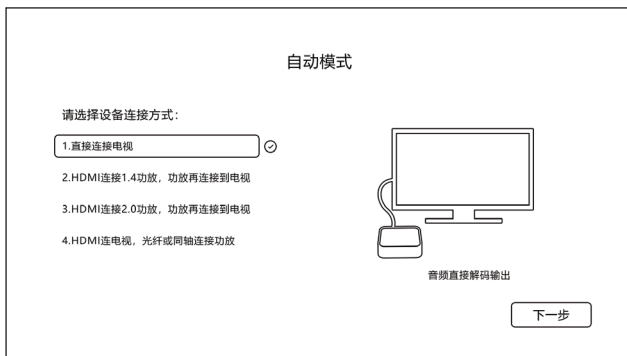

专家模式：音视频输出为自定义选择模式，可根据设备连接和支持的规格选择相应的音视频输出，此模式建议专业人员操作。

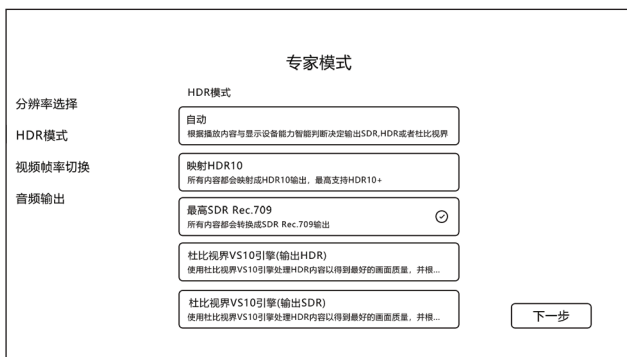

4. 按键定义

根据您的使用习惯定义遥控器上的数字键，选时键，字幕键，音轨键，上下键，翻页键对应的功能。



完成以上设置后，按照提示点下一步，了解主界面功能介绍后完成整个设备的初始化设置，即可享受芝杜产品给您带来的影音盛宴。

OTA 系统升级

芝杜 Zidoo 会不定期更新固件。

在 APPS 应用中心找到系统升级图标点击打开；支持在线网络升级及本地升级两种方式；勾选自动检测最新版本后，您将会自动收到最新的系统升级提示。



1. 在线升级

点击“在线升级”选项，获取在线升级信息。

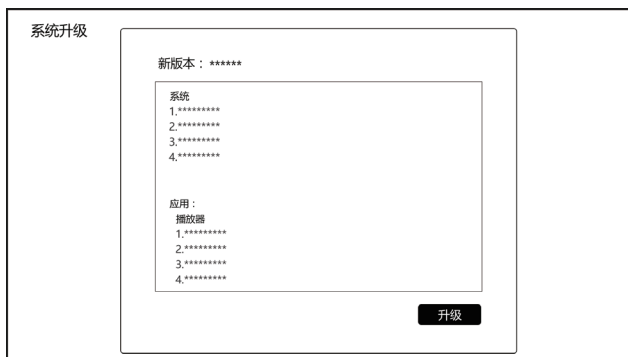

2. 本地升级

用户可通过在论坛或官网手动下载升级文件，通过本地升级的方式自行升级系统。

将下载好的升级文件拷贝到U盘，通过点击本地升级选项，选择升级文件。

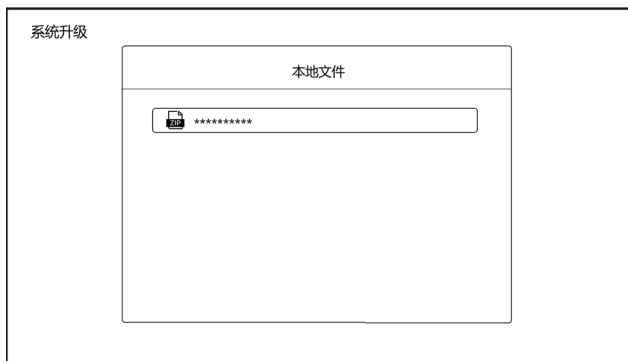

通过在线升级或本地升级下载完升级文件后，通过点击“升级”选项，开始升级。

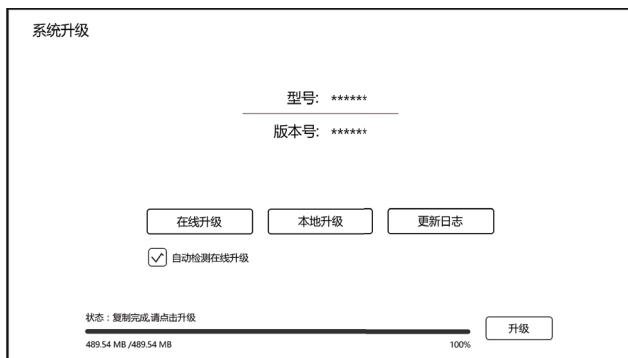

系统会自动检验升级文件是否完整。

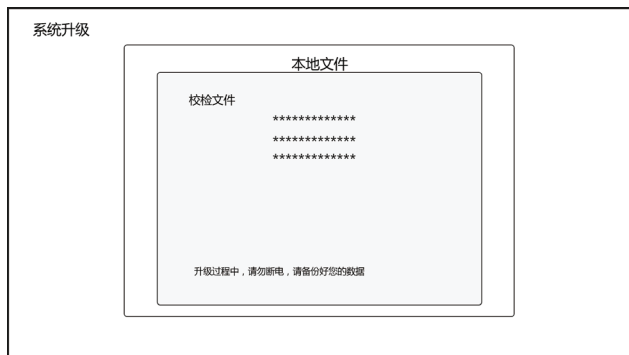

注意：自动进入系统升级，该过程请不要断电。

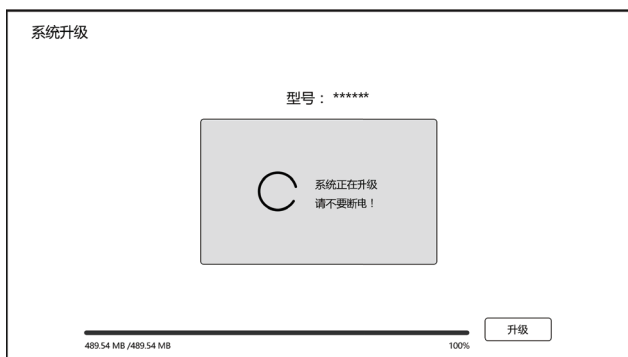

升级完成，自动重启系统。

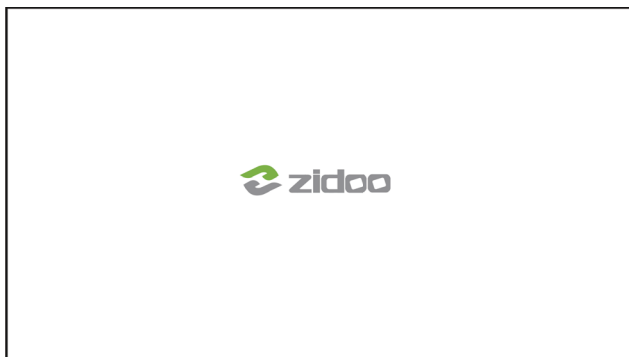

特别说明：

为了保证用户体验，芝杜 Zidoo 会不定期更新固件。因此，本说明书的操作说明，有可能会与产品实际使用情况稍有出入。

Introduction to Hardware of Z20 PRO

Device Interface

Zidoo Z20 PRO is equipped with audio and video input & output ports and data transmission ports. Please refer to the descriptions in this manual.

1. Front

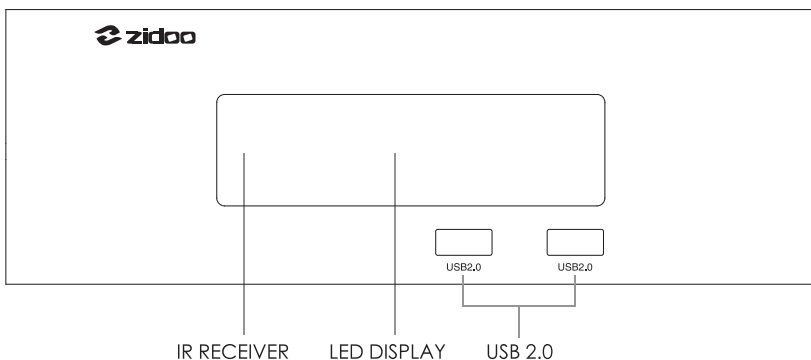

2. Right



3. Back

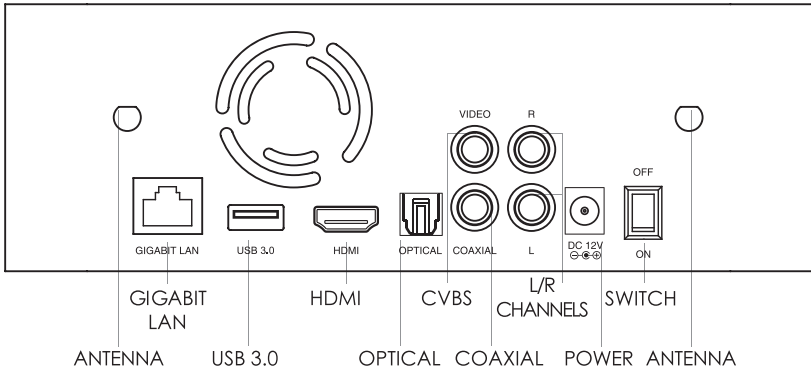

Instruction to installation of the antenna: Please insert the two antennas in the parcel into the antenna ports in the above diagram.

Note:

*Please load/change the hard disk after turning off the power. If it is a brand-new hard disk, Please load it after formatting it.

*Please prevent the orifice of the cooling fan from being blocked.

*Do not touch any liquid in case the liquid runs into the inner part of the device and damage it.

*Any maintenance personnel who are not appointed are not allowed to open the case.

Load the Hard Disk

Z20 PRO is equipped with 3.5 inches HDD Bay and high speed SATA transmission port. The hard disk can be loaded by pushing with hand. (The maximum hard disk supports 14 TB)

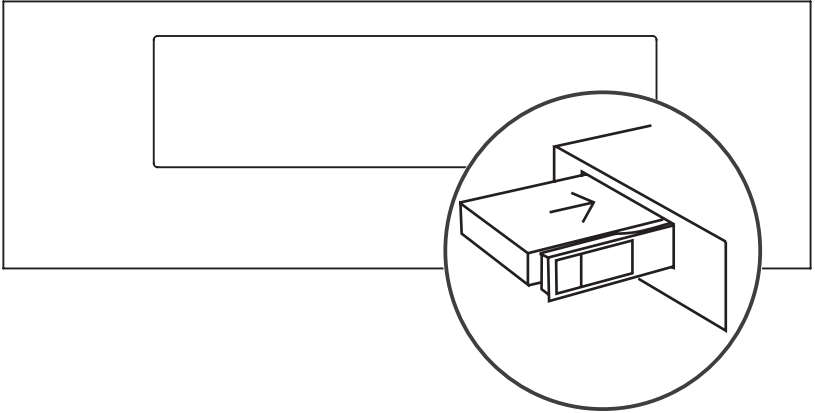

Note: Do not load or change the hard disk while the power is on to avoid damage of the device or hard drive data. If it is a brand-new hard disk, please format it before loading it to the device. This device supports hard disk of the following formats: EXT3, EXT4, NTFS, FAT32, EXFAT.

Device Connection

1. Connect HDMI Cable to TV

1) Cut off the power. Please make sure the power of the TV and media player are off.



2) When the TV is turned off, please connect HDMI OUT port on Zidoo to HDMI IN port on TV.



3) Connect with the power. This device is equipped with suitable DC power adapter. Please connect the head of DC power adapter to the DC power input port of this device, then insert the plug of DC power adapter into the socket of 110V – 240V.

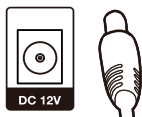

4) Corresponding video source is selected by TV.

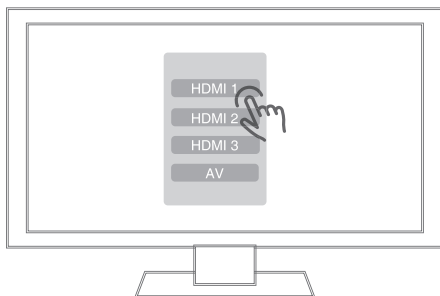

2. Connect AV Cable to the TV

The connection method is same as connecting HDMI cable.

3. Assembly Sequence to Connect RS232 to 3.5mm Connector

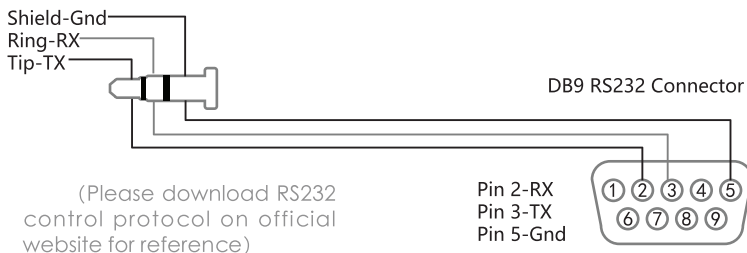

Z20 PRO Specification

Front Display	LED
Shell	Aluminum Alloy
OS	Android 11
CPU	Realtek RTD1619BPD ARM Cortex-A55(Quad-core)
GPU	ARM Mali-G57
NPU	1.6TOPS
RAM	4GB DDR4
Internal Storage	32GB eMMC
Bluetooth	BT 5.2
WIFI	2.4G + 5G dual-band WiFi, 802.11 a/b/g/n/ac/ax 2T2R, 802.11ax MIMO OFDM
Ethernet	1*RJ-45 Ethernet Jack (10/100/1000Mbps)
HDMI Out	HDMI 2.1, support up to 4K @ 60p, HDR, 12Bit, YCbCr 4:4:4 color range, support audio pass-through
Video Decoding	4K@60p,AV1/HEVC/H.265,12Bit, HDR10, HDR10+, Dolby vision
Audio Decoding	Support high-definition audio pass-through and audio decode
Intelligent Control	Mobile APP control, RS-232, TCP/IP control and WOL support
SATA	1*HDD Bay
USB	1*USB 3.0, 2*USB 2.0
Power Supply	DC 12V 2A
Other interface	1*IR Receiver, 1*RCA Cvbs, 1*RCA Audio L/R Channels, 1*Coaxial/1*SPDIF(2CH, 5.1CH), 1*3.5 (mm) RS-232, 2*External High-Gain Antenna

Boot Initialization Wizard

Before using the machine formally, the system will perform the initial setup. Please set according to devices and requirements to get the best visual experience.

1. System language selection, screen zoom, time zone setting

Choose the system language according to your language habit.

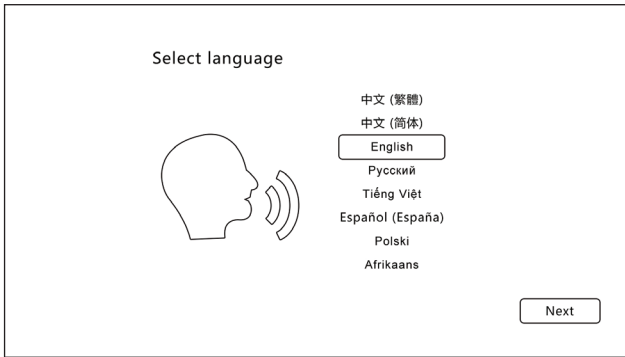

Press the UP and DOWN buttons on remote control to adjust screen display area.

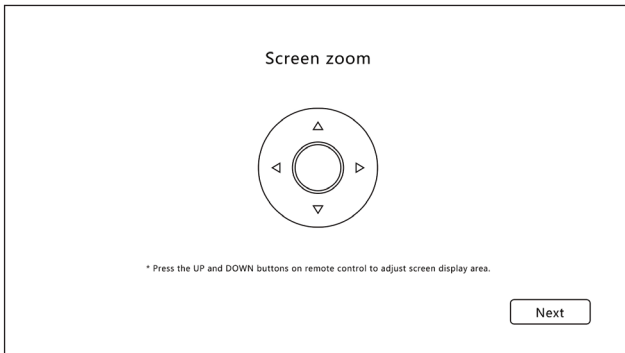

Select the time zone for the system according to your location.

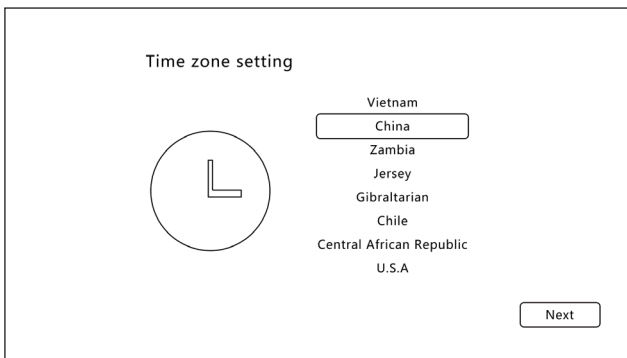

2. Network Setting

Configure network to connect device with network quickly.

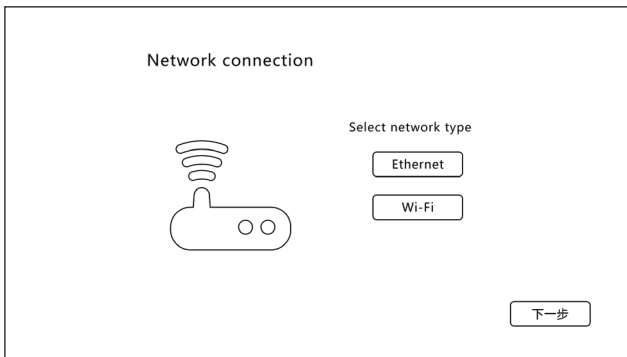

WiFi: choose network SSID, input password and connect WiFi.

Ethernet: plug in the network cable to connect the network automatically .

3. Select output mode

Please select the corresponding mode according to your needs, then it will finish relevant setting.

Wizard mode: select the corresponding option according to your usage environment and device connection.

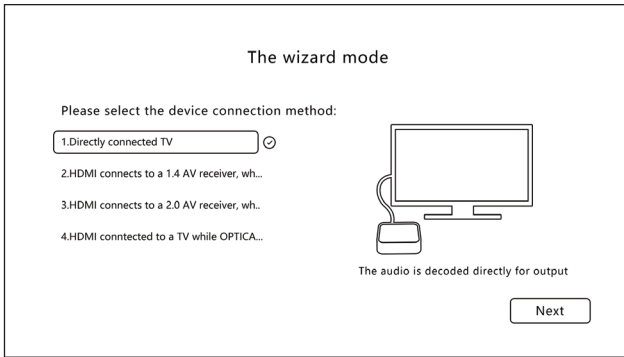

Expert mode: The audio and video output is customized by users, it is recommended for professionals.

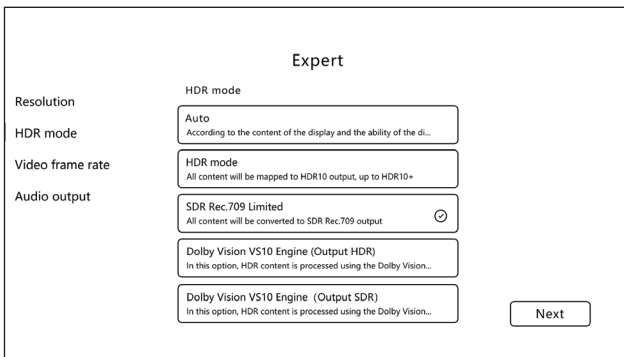

4. The key definition

Define the corresponding functions for number keys, timing key, subtitle key, audio key, up and down keys and page keys on the remote control according to your usage habits.

The key definition

Number keys	Specific percentage of video >
Timing keys	Close >
Subtitle keys	Subtitle list >
Audio keys	Audio list >
Up and Down keys	Switch chapter >
Page Turning Keys	Switch chapter >

After completing settings above, please follow prompts and click “Next” until entering Zidoo user interface. Enjoy Zidoo audiovisual feast!

OTA System Update

Zidoo will update the firmware from time to time.

Find the update icon in APPs and click it, online update and local update are supported. After ticking "Automatically check online upgrade", you will receive the prompt for the latest firmware update automatically.



1. Online Update

Click "Online Update" to obtain information of online update.

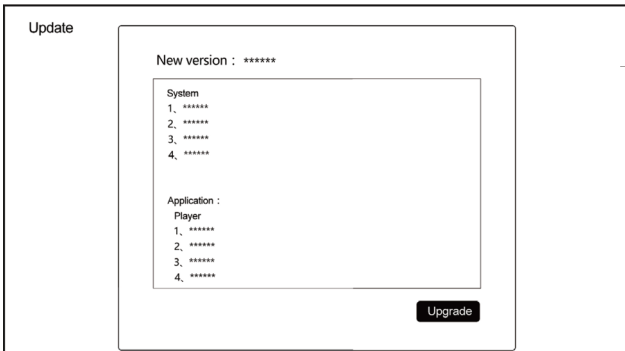

2. Local Update

Users can download the update files on the forum or official website and update firmware through files.

Copy the downloaded update file to USB disk. Click "USB update" to select the update file.

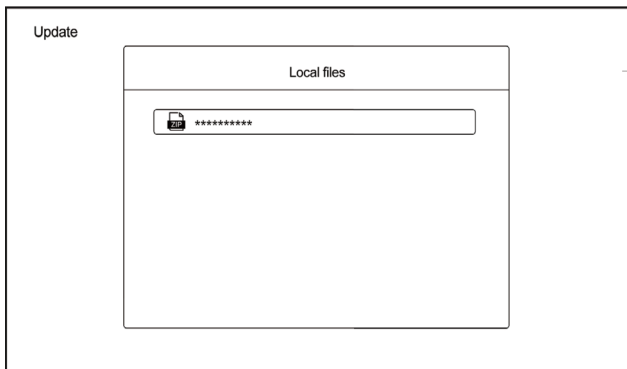

Download the update file by online update or local update. Click "Update" to update it.

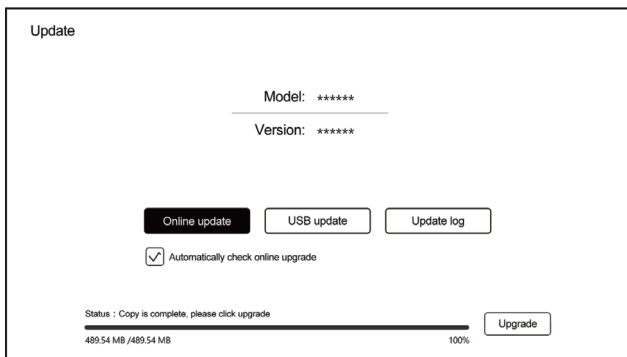

The system will automatically check the update file whether is completed or not.

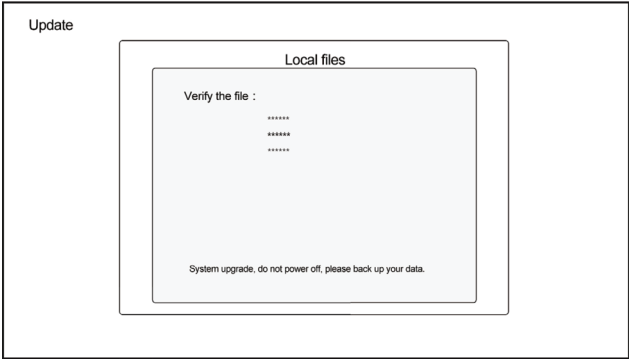

Note: Automatically access to system upgrade. Please don't power off in the progress.

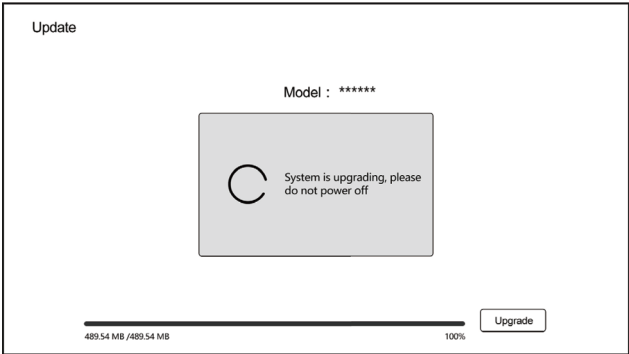

Once the update process is completed, the system will automatically restart.



Special Note:

To guarantee user experience, Zidoo will update the firmware from time to time. Therefore, this manual may not be totally in line with the product.

Guarantee

保修卡

User File

用户信息

User name 用户姓名		Sex 性别	
Address 回寄地址			
Telephone 联系电话		Zip 邮编	
Product name 产品名称		Model NO. 型号	
Fault description 故障说明			

Guarantee Item

保修条款

- (1) One year guarantee from date of purchased(not including fittings).
- (2) All of damage by man-made(tear open the housing, tear off the sticker, unnormally using), or losing this card, we will not guarantee.
- (3) 保修期限：本产品遵循国家三包条例，商品存在非人为损坏所引起的硬件故障，本公司将提供一年保修服务（配件除外）。
- (4) 如需寄回本公司维修，请与此保修卡一同寄回。
- (5) 一切人为因素造成的损坏（包括擅自拆机，撕毁标签，自行刷机等等），本公司将不予保修。



QUALIFIED
CERTIFICATE
合格证

CHECKER/检验员 _____

DATE/日期 _____