

感谢您使用芝杜 zidoo 旗下产品，您可以关注我们的社交平台账号，
和我们一起交流与分享。

Thank you for choosing products of Zidoo. Friend us on
WeChat or Weibo to communicate and share with us.



微信公众号 @ **zidoo**
WeChat Official Account



微博账号 @ 芝杜官方
Weibo Account



Facebook @ **zidoottv**



Twitter @ **zidoottv**

如需更多帮助，请访问芝杜 zidoo 官网的用户论坛进行咨询。

If you need more assists, please visit user forum of the official
website of Zidoo for consultation.



官网网址 /Official website: www.zidoo.tv

目录 /Content

01	Z1000 硬件介绍	
	设备接口	P1
	装载硬盘	P3
	遥控器	P4
	设备连接	P5
	性能参数	P7

02	初始化	P8
-----------	------------	----

03	OTA 系统升级	P10
-----------	-----------------	-----

01 Introduction to hardware of Z1000

Device Interface	P14
Installation of hard disk	P16
Remote Control	P17
Device Connection	P18
Performance Parameters	P20

02	Initialization	P21
-----------	-----------------------	-----

03	System update by OTA	P23
-----------	-----------------------------	-----

Z1000 硬件介绍

设备接口

Zidoo Z1000 配备有丰富的音视频输入输出接口及数据传输接口，请参考本手册内容。

1. 正面

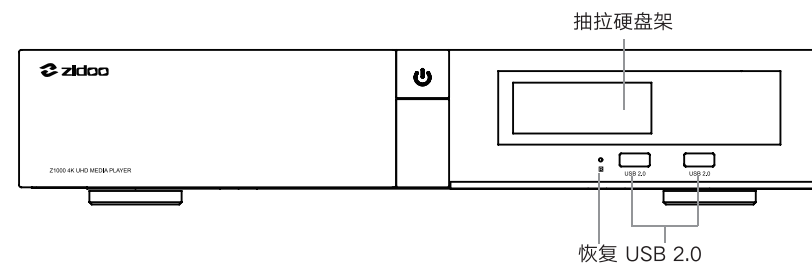
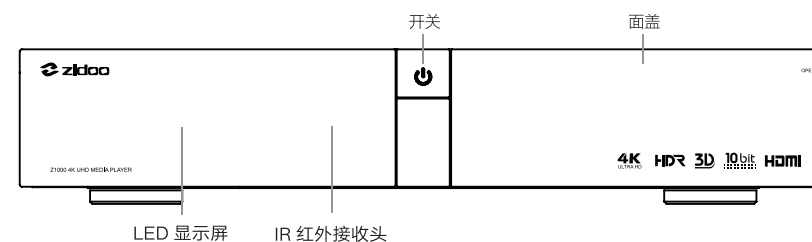

2. 左侧

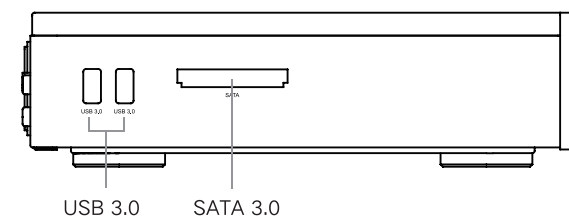

3. 右侧

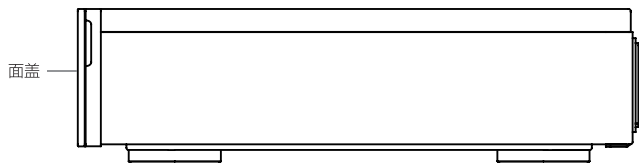

4. 背面

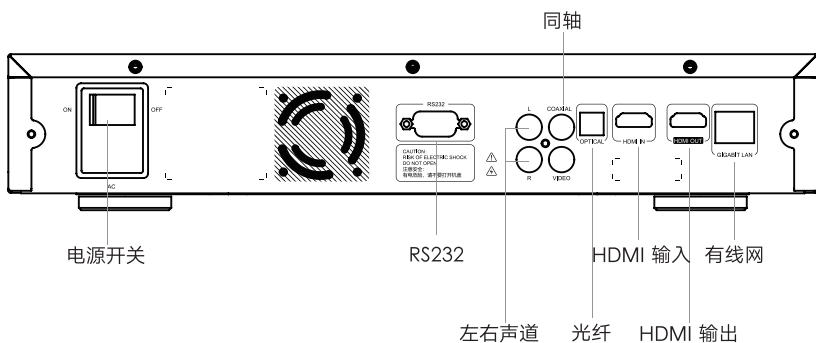

注意:

- * 请在断电的状态下装载 \ 更换硬盘, 如是全新硬盘, 请格式化后装载。
- * 请不要将任何东西遮挡散热风扇孔。
- * 请不要接触液体, 以免流入设备内部造成损坏。
- * 非指定维修人员, 请不要拆开机壳。

装载硬盘

Z1000 搭载 3.5 寸硬盘仓, 内置 SATA 高速传输接口, 无需借助任何工具, 将硬盘 SATA 接口朝里轻松推入即可装载 (硬盘最大支持 10TB)。

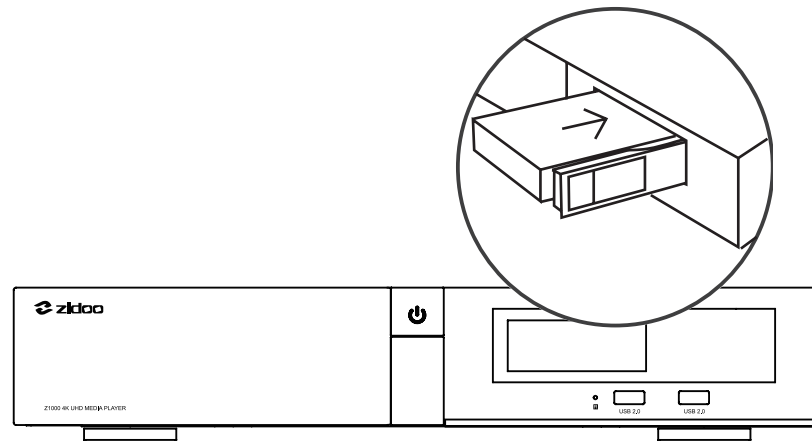

注意: 请勿在设备通电的状态下装载或更换硬盘, 以免造成设备或硬盘数据损坏, 如果是全新硬盘, 请先格式化硬盘再装载至设备, 本机支持硬盘格式为 :EXT3,EXT4,NTFS,FAT32,EXFAT。

遥控器

1. 键位功能描述

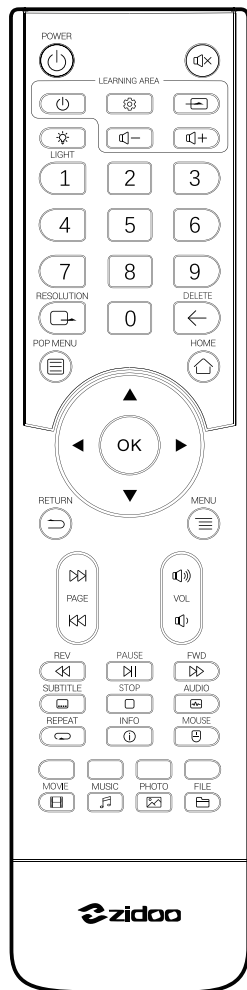

功能	按键
开关	
学习区域	
音量 +/ 音量 -/ 静音	
播放	
多媒体信息	
导航菜单	
翻页	
鼠标	
主页	
返回	
菜单	
分辨率	
灯光	
删除	
数字	1/2/3/4/5/6/7/8/9/0
功能键	
快捷方式	

2. 学习键介绍

此款遥控器的学习功能可以将其它遥控器的某些按键功能复制到本遥控器上来，用一个遥控器即可完成两个设备的操控。

学习键的操作说明：

- ① 将本遥控器和需要学习的遥控器头部相对，红外线发射管相互对齐。
- ② 按住本机遥控器学习区的 键不放，直到本机遥控器的白色背光亮起。
- ③ 按一下本机遥控器学习区的任一按键，本机遥控器白色背光快速闪烁一下。
- ④ 再按一下需要学习的遥控器上的功能按键，（本机遥控器收到信号后白色背光会快速闪烁两次）。
- ⑤ 如有多个按键功能需要学习，请重复第 3 第 4 步。
- ⑥ 学习完毕后，按下本机遥控器学习区外任一按键，即可退出学习模式，随后本机遥控器白色背光灯自动熄灭即学习完成。

设备连接

1. HDMI 连接电视

- ① 将设备断电，请务必保证电视机与机顶盒都在断电的状态下操作。

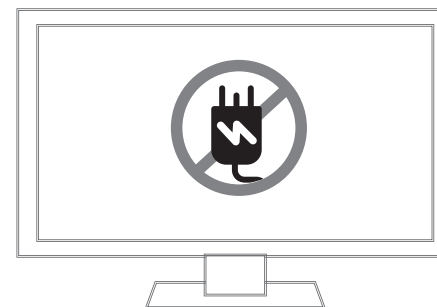

- ② 在 TV 断电的状态下将 HDMI 线一头插入设备的 HDMI OUT、一头插入电视 HDMI IN 接口。



HDMI OUT



HDMI IN

③ 电源连接：本设备内置电源，请将随机附赠的电源线加入本机的 AC 电源插座，将电源线的另一头接入交流 110~240V 的电源插座后，打开 AC 电源插座上的电源开关。

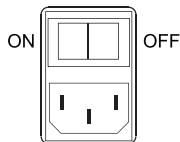

④ 按下机器前面板的开机按钮或按下遥控器电源键进行开机，并打开电视机。

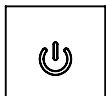

⑤ 电视选择对应的视频源。

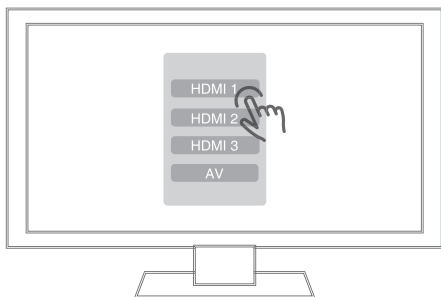

2. AV 线连接电视

连接方式同 HDMI 线的连接方式。

Z1000 性能参数

材料	航空铝合金
前置显示	LED
机身	航空铝合金
系统	Android + OpenWRT
CPU	Realtek RTD1296 ARM Cortex-A53 四核
GPU	ARM T820 MP3(3 核)
内存	2GB DDR
内部储存器	16GB eMMC
Wifi 连接	802.11AC MIMO 双频 WIFI
以太网	1*RJ-45 以太网插孔 (10/100 / 1000Mbps)
HDMI 输出	HDMI 2.0a, 支持 4K@60fps, HDR10
HDMI 输入	HDMI 2.0
视频解码	HDR, 10 位 HEVC/H.265 高达 4K@60fs, VP9 高达 4K@60fps, H.264 高达 4K@24fps
音频解码	支持高清音频多声道直通和立体声解码
硬盘仓	1*SATA 3.0
USB	2*USB 3.0, 2*USB 2.0
输入	100-240V ~ 50/60Hz Max 1.3A
其他接口	1* 红外接收器, 1*RCA 视频, 1*RCA 左右声道 1* 同轴, 1*SPDIF 光纤 (2CH, 5.1CH), 1*RS232, 1*SATA 3.0

初始化

正式使用机器前，本软件将为您进行第一次初始化设置，请根据初始化设置流程设置您的设备，以获得最佳的观影体验。

1. 系统语言

根据个人需要设置系统语言。



2. 屏幕缩放

通过遥控器左右键或鼠标中键滑轮调整屏幕显示范围到合适的大小。



3. 网络设置

设置相关网络配置，让机器快速连接网络。网络分为无线网络和有线网络，选择其中一种连接成功即可。



无线网络 (WIFI)：选择网络 SSID，输入密码，连接 WIFI 即可完成设置。
有线网络：无需其他操作，只需插入网线即可自动联网。网络设置完成后点击下一步了解主界面功能即可完成整个设备的初始化。



OTA 系统升级

芝杜 ZIDOO 会不定期更新固件。

在 APPS 应用中心找到系统升级图标点击打开；支持在线网络升级及本地升级两种方式；勾选自动检测最新版本后，您将会自动收到最新的系统升级提示。



1. 在线升级

点击“在线升级”选项，获取在线升级信息。

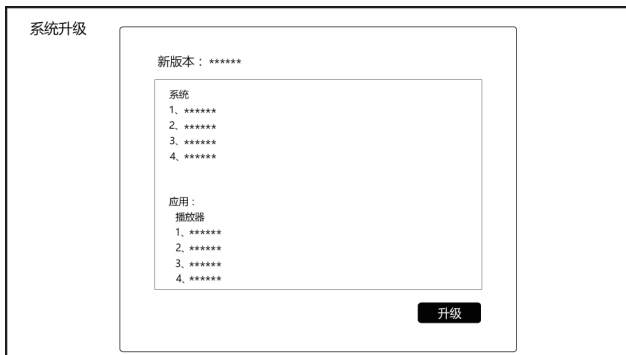

2. 本地升级

用户可通过在论坛或官网手动下载升级文件，通过本地升级的方式自行升级系统。

将下载好的升级文件拷贝到 U 盘，通过点击“本地升级”选项，选择升级文件。



通过在线升级或本地升级下载完升级文件后，通过点击“升级”选项，开始升级。

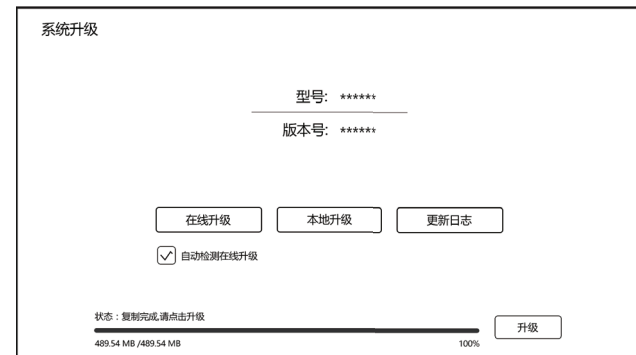

系统会自动检验升级文件是否完整。



升级完成, 自动重启系统。



注意: 自动进入系统升级, 该过程请不要断电。

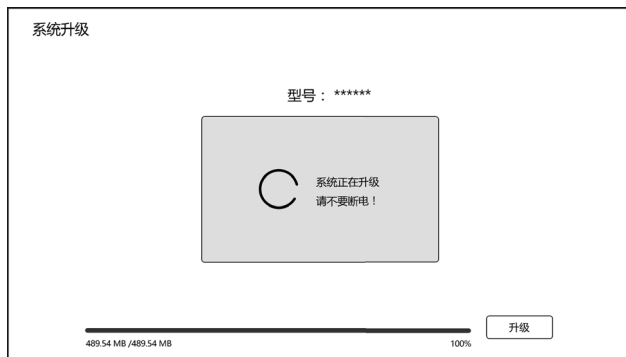

特别说明:

为了保证用户体验, 芝杜 ZIDOO 会不定期更新固件。因此, 本说明书的操作说明, 有可能会与产品实际使用情况稍有出入。

Introduction to hardware of Z1000

Device interface

Zidoo Z1000 is equipped with audio input & output ports and data transmission port. Please refer to the descriptions in this manual.

1. Front

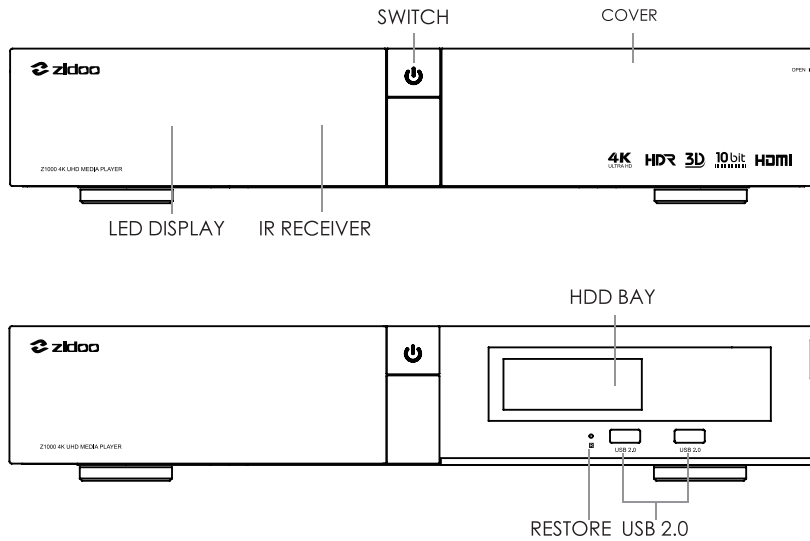

2. Left

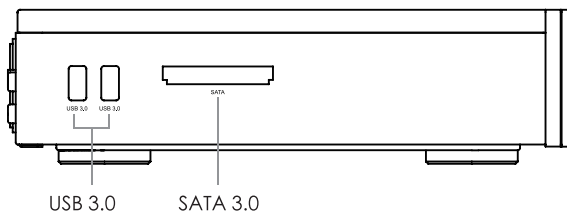

3. Right

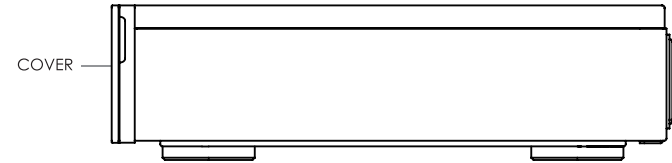

4. Back

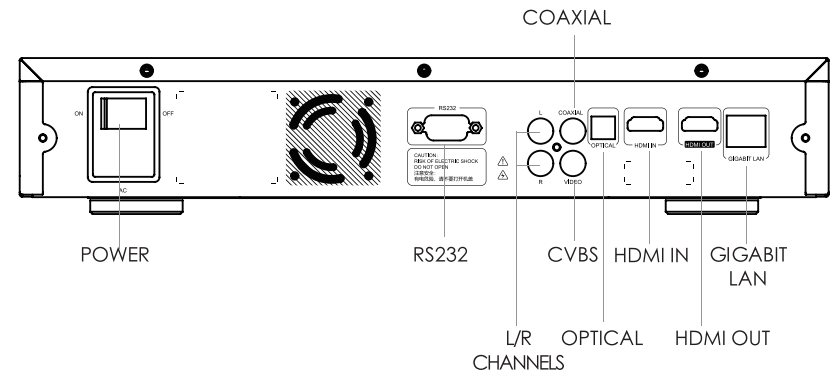

Note:

- *Please load/change the hard disk after turning off the power. If it is a brand-new hard disk, Please load it after formatting it.
- *Please prevent the orifice of the cooling fan from being blocked.
- *Do not touch any liquid in case the liquid runs into the inner part of the device and damage it.
- *Any maintenance personnel who are not appointed are not allowed to open the case.

Load The Hard Disk

Z1000 is equipped with hard disk storage of 3.5 inches and SATA high speed transmission port. The hard disk can be loaded by pushing in, with no other tools. (The maximum hard disk supports 10 TB)

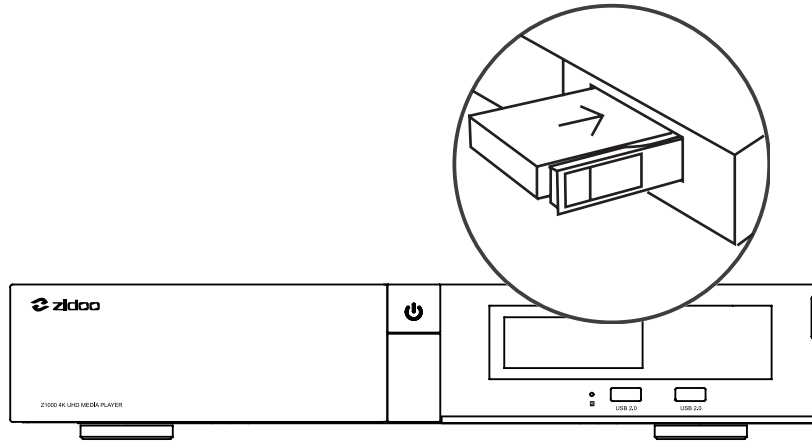

Note: Do not load or change the hard disk while the power is on to avoid that the device or the data of hard disk be damaged. If it is a brand-new hard disk, please format it before loading it to the device. This device support following formats of hard disk: EXT3, EXT4, NTFS, FAT32, EXFAT.

Remote Control

1. Button Features Description

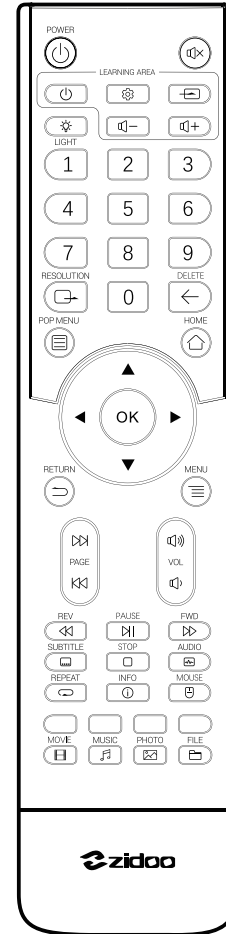

Functions	Buttons
Turn on/off	
TV Learning Area	
VOL+/VOL-/Mute	
Playback	
Mediainfo	
Pop Menu	
Page up/down	
Mouse	
Home	
Return	
Menu	
Resolution	
Light	
Delete	
Numbers	1/2/3/4/5/6/7/8/9/0
Multi-Function	
Shortcut	

2. Learning Button Introduction

Learning function: This remote control can copy functions of buttons from other remote control so that can control two devices.

Operation descriptions of Learning Button:

- 1) Point the top of this remote control to that of the remote control to be copied, align the infrared transmitting tubes.
- 2) Press  in the study area of this remote control until its white backlight is activated.
- 3) Press any button in the study area of this remote control, its white backlight flashes once.
- 4) Press the function button of the remote control to be copied. After the remote control receives the signal, the white backlight will quickly flash twice.
- 5) If there are many functions need to be learned, please repeat step 3 and 4.
- 6) After completing learning, press any buttons outside the learning area of this remote control to exit learning mode. Then the white backlight of this remote control will turn off automatically and completed learning.

Device Connection

1. HDMI connects to the TV

- 1) Cut off the power of the device. Please make sure the power of the TV and STB at OFFS Model.

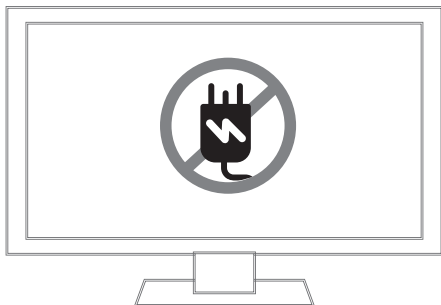

- 2) While the power of TV is turned off, insert one end of HDMI cable into HDMI OUT port and insert the other end into HDMI IN port.



- 3) Connect with the power. This device is equipped with suitable AC power adapter. Please connect the head of AC power adapter to the AC power input port of this device, then insert the plug of AC power line into the alternating current socket of 110V -240V.

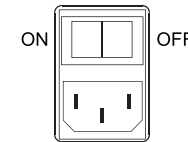

- 4) Press the power button on the front panel of the machine or press the power button on remote control to turn it on. And turn on the TV.

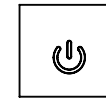

- 5) Corresponding video source is selected by TV.

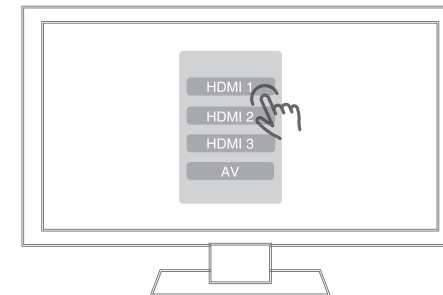

2. Connect AV cable with the TV

The connection method is same as connecting HDMI cable.

Z1000 Specification

Material	Aviation Aluminum Alloy
Front Display	LED
Shell	Aviation Aluminum Alloy
OS	Android + OpenWRT
CPU	Realtek RTD1296 ARM Cortex-A53 Quad-Core
GPU	ARM T820 MP3(3-Core)
Memory	2GB DDR
Internal Storage	16GB eMMC
WIFI Connectivity	802.11 AC MIMO Dual-Band WIFI
Ethernet	1*RJ-45 Ethernet Jack (10/100/1000Mbps)
HDMI Out	HDMI 2.0a, Support 4K@60fps, HDR10
HDMI In	HDMI 2.0
Video Decoder	HDR, 10-bit HEVC/H.265 up to 4K@60fp VP9 up to 4K@60fps, H.264 up to 4K@24fps
Audio Decoder	Support HD audio multichannel direct access and stereo decoding
HDD Bay	1*SATA 3.0
USB	2*USB 3.0, 2*USB 2.0
Input	100-240V ~ 50/60Hz Max 1.3A
Other interface	1*IR Receiver, 1*RCA Cvbs, 1*RCA Audio L/R Channels, 1*Coaxial, 1*SPDIF(2CH, 5.1CH), 1*RS232, 1*SATA 3.0

Initialization

Before actually using this device, you will be provided with this software for the first initialization. Please set your device according to the initialization process to obtain the optimum watching experience.

1. System Language

Select the language of the system as you want.



2. Screen Scaling

Adjust the screen display range using LEFT or RIGHT button of the remote control (Mouse Wheel) so that the image can be appropriately displayed on the screen of the TV.

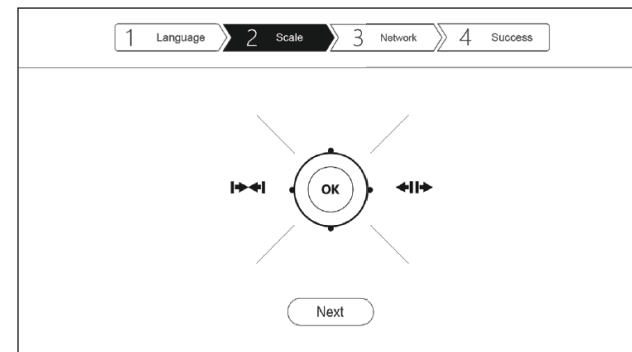

3. Network Setting

Set the configuration of the network so that the device can quickly connect with the network. The network is including WIFI network and Ethernet network. Select either of them and successfully connect with it.

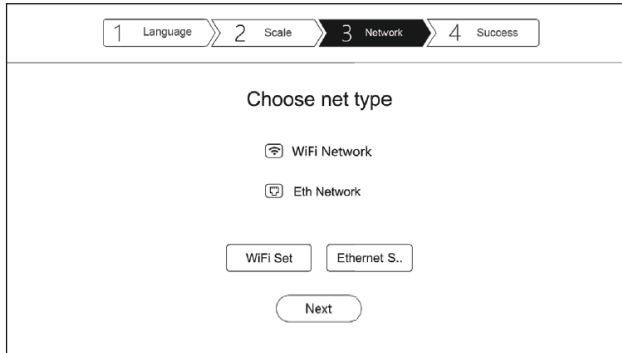

WIFI: Select SSID and enter password, connect to WIFI and finish setting.

Ethernet Network: No other operation needed except that inserting cable and then automatically connect to internet. After completed the Internet setting, please click "NEXT" to further steps and get to know the function of the Home Page and finish initialization.

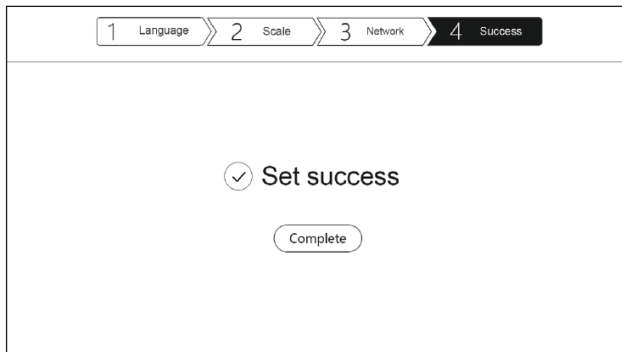

System update by OTA

Zidoo will update the firmware aperiodicity. Find the system update icon in APP center and open it; Support online network update and local update; After ticking "Automatically detect the latest version", you will receive the prompt for the latest firmware update automatically.



1. Online Update

Click "Online Update" to obtain information of online update.

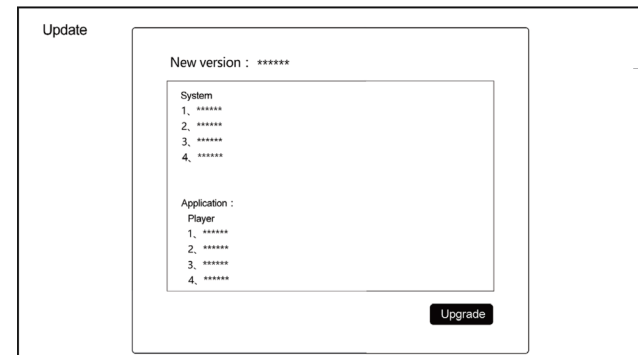

2. Local Update

Users can download the update files on the forum or official website and update firmware through files. Copy the downloaded update files to USB disk. Click "USB update" to select the update files.

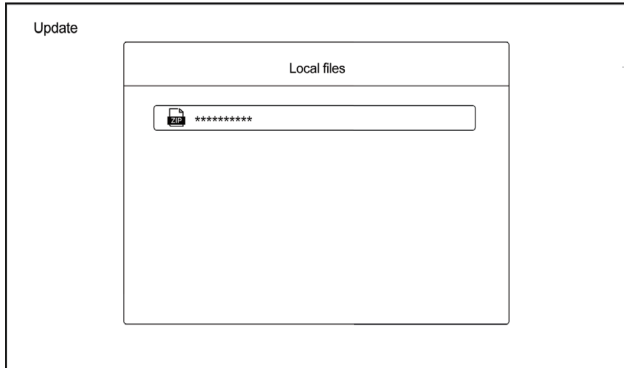

Download the update files by online update or local update. Click "Update" to update.

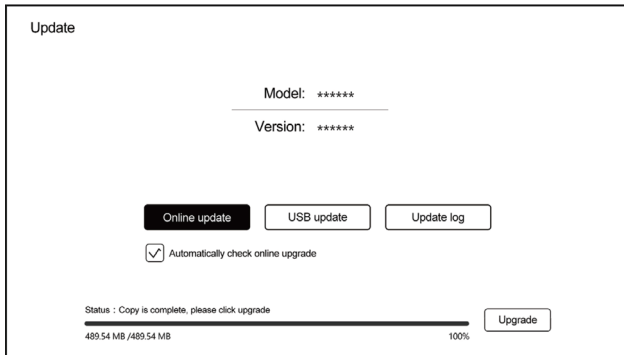

The system will automatically check the update files whether is complete or not.

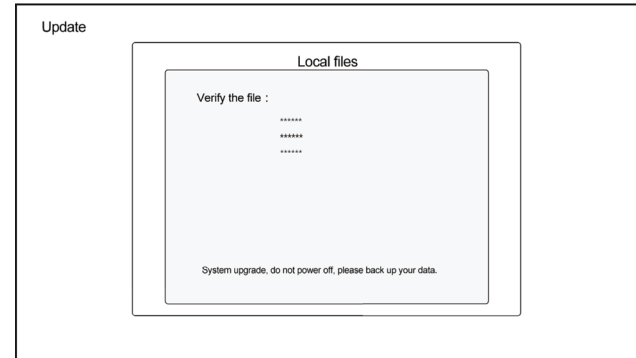

Note: Automatically access to system upgrade. Please don't power off in the progress.

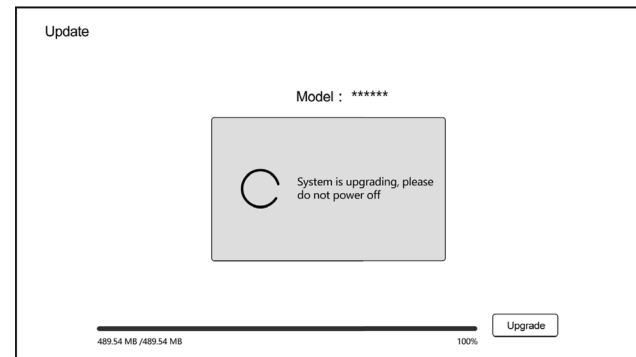

Once the update is completed, the system will automatically be restarted.



Special Note:

To guarantee user experience, Zidoo will update the firmware aperiodicity. Therefore, this manual may not be totally in line with the product.

Guarantee 保修卡

User File 用户信息

User name 用户姓名		Sex 性别	
Address 回寄地址			
Telephone 联系电话		Zip 邮编	
Commodity name and specification 产品名称		Model NO. 型号	
Fault description 故障说明			

Guarantee Item 保修条款

- (1) One year guarantee from date of purchased. (not including fittings)
 - (2) All of damage by man-made(tear open the housing,tear off the sticker,unnormally using),or losing this card,we will not guarantee.
- (1) 保修期限：本产品遵循国家三包条例，商品存在非人为损坏所引起的硬件故障，本公司将提供一年保修服务（配件除外）。
 - (2) 如需寄回本公司维修，请与此保修卡一同寄回。
 - (3) 一切人为因素造成的损坏（包括擅自拆机，撕毁标签，自行刷机等等），本公司将不予保修。



Warning:

This device complies with Part 15 of the FCC Rules. Operation is subject to the following two conditions: (1) this device may not cause harmful interference, and (2) this device must accept any interference received, including interference that may cause undesired operation.

changes or modifications not expressly approved by the party responsible for compliance could void the user's authority to operate the equipment.

NOTE: This equipment has been tested and found to comply with the limits for a Class B digital device, pursuant to Part 15 of the FCC Rules. These limits are designed to provide reasonable protection against harmful interference in a residential installation. This equipment generates, uses and can radiate radio frequency energy and, if not installed and used in accordance with the instructions, may cause harmful interference to radio communications. However, there is no guarantee that interference will not occur in a particular installation. If this equipment does cause harmful interference to radio or television reception, which can be determined by turning the equipment off and on, the user is encouraged to try to correct the interference by one or more of the following measures:

- Reorient or relocate the receiving antenna.
- Increase the separation between the equipment and receiver.
- Connect the equipment into an outlet on a circuit different from that to which the receiver is connected.
- Consult the dealer or an experienced radio/TV technician for help.

NOTE: This device and its antenna(s) must not be co-located or operation in conjunction with any other antenna or transmitter

RF Exposure Statement

To maintain compliance with FCC's RF Exposure guidelines, This equipment should be installed and operated with minimum distance of 20cm the radiator your body. This device and its antenna(s) must not be co-located or operation in conjunction with any other antenna or transmitter

