

感谢您使用芝杜 zidoo 旗下产品，您可以关注我们的社交平台账号，  
和我们一起交流与分享。

Thank you for choosing products of Zidoo. Friend us on  
WeChat or Weibo to communicate and share with us.



微信公众号 @ **zidoo**  
WeChat Official Account



微博账号 @ 芝杜官方  
Weibo Account



Facebook @ **zidoottv**



Twitter @ **zidoottv**

如需更多帮助，请访问芝杜 zidoo 官网的用户论坛进行咨询。

If you need more assists, please visit user forum of the official  
website of Zidoo for consultation.



官网网址 /Official website: [www.zidoo.tv](http://www.zidoo.tv)

# 目录 /Content

<b>01</b>	<b>Z10 硬件介绍</b>	
	设备接口	P1
	硬盘转载	P3
	遥控器	P4
	设备连接	P5
	性能参数	P7

<b>02</b>	<b>初始化</b>	P8
-----------	------------	----

<b>03</b>	<b>OTA 系统升级</b>	P10
-----------	-----------------	-----

## 01 Introduction to hardware of Z10

Device Interface	P14
Installation of hard disk	P16
Remote Control	P17
Device Connection	P18
Performance Parameters	P20

<b>02</b>	<b>Initialization</b>	P21
-----------	-----------------------	-----

<b>03</b>	<b>System update by OTA</b>	P23
-----------	-----------------------------	-----

# Z10 硬件介绍

## 设备接口

Zidoo Z10 配备有丰富的音视频输入输出接口及数据传输接口，请参考本手册内容。

### 1. 正面

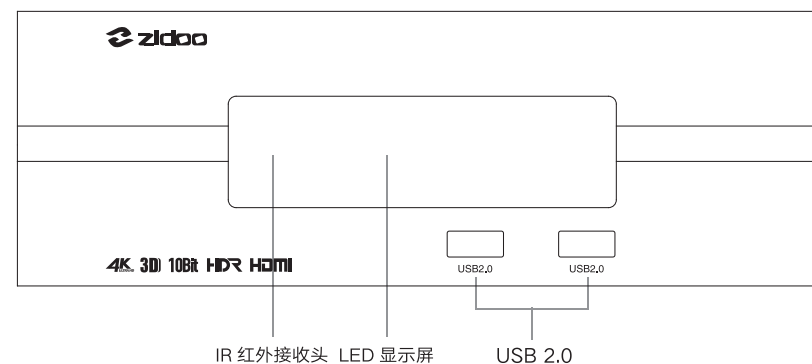

### 2. 右侧

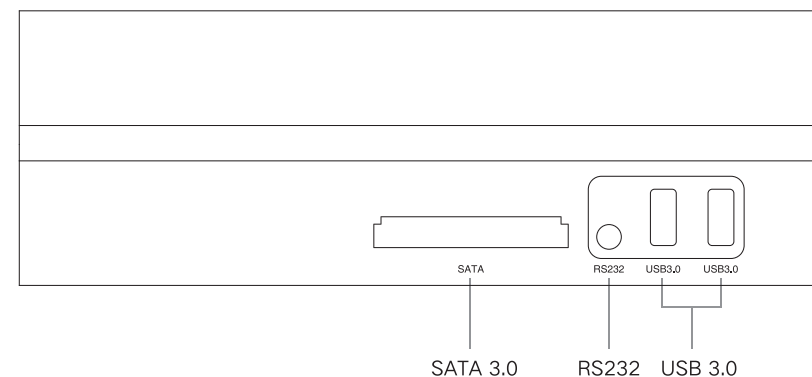

### 3. 左侧

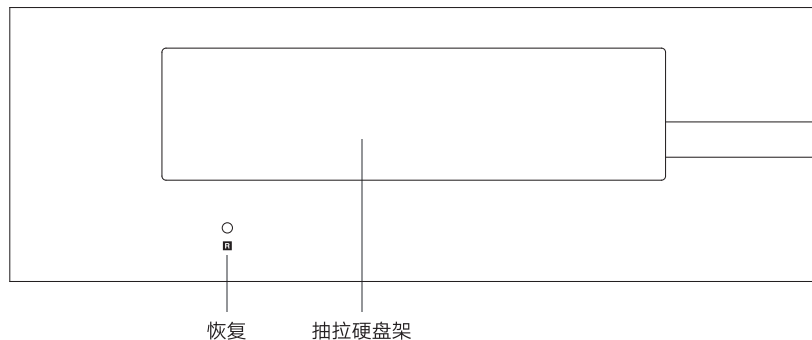

### 4. 背面

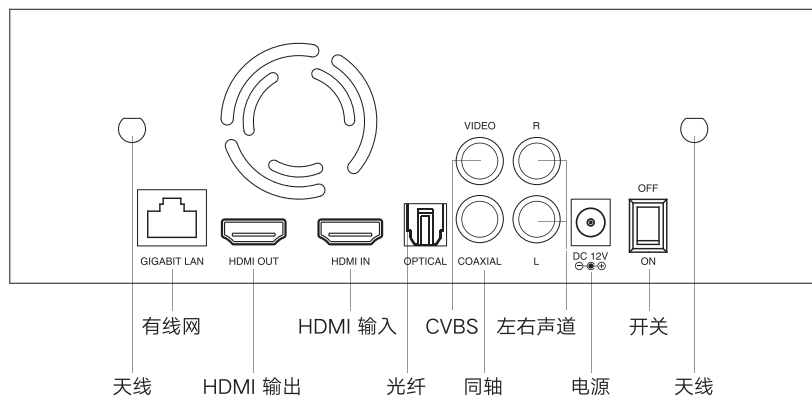

天线安装说明：请将附件中的两根天线安装至上图所示的天线接口。

**注意：**

- \* 请在断电的状态下装载\更换硬盘，如是全新硬盘，请格式化后装载。
- \* 请不要将任何东西遮挡散热风扇孔。
- \* 请不要接触液体，以免流入设备内部造成损坏。
- \* 非指定维修人员，请不要拆开机壳。

### 装载硬盘

Z10 搭载 3.5 寸硬盘仓，内置 SATA 高速传输接口，无需借助任何工具，将硬盘 SATA 接口朝里轻松推入即可装载（硬盘最大支持 10TB）。

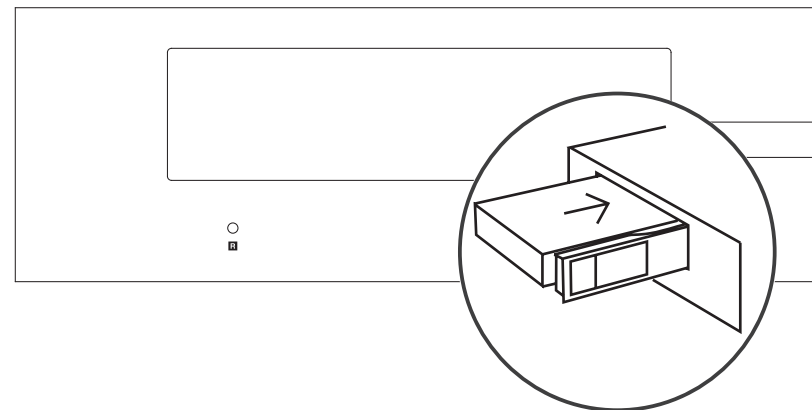

**注意：**请勿在设备通电的状态下装载或更换硬盘，以免造成设备或硬盘数据损坏，如果是全新硬盘，请先格式化硬盘再装载至设备，本机支持硬盘格式为：EXT3,EXT4,NTFS,FAT32,EXFAT。

## 遥控器

### 1. 键位功能描述

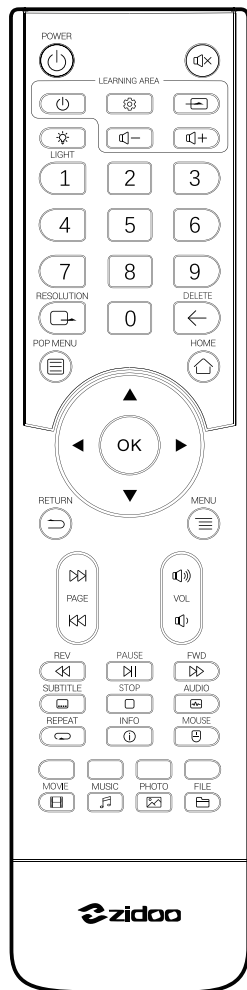

功能	按键
开关	
学习区域	
音量 +/ 音量 -/ 静音	
播放	
多媒体信息	
导航菜单	
翻页	
鼠标	
主页	
返回	
菜单	
分辨率	
灯光	
删除	
数字	1/2/3/4/5/6/7/8/9/0
功能键	
快捷方式	

### 2. 学习键介绍

此款遥控器的学习功能可以将其它遥控器的某些按键功能复制到本遥控器上来，用一个遥控器即可完成两个设备的操控。

学习键的操作说明：

- ① 将本遥控器和需要学习的遥控器头部相对，红外线发射管相互对齐。
- ② 按住本机遥控器学习区的 键不放，直到本机遥控器的白色背光亮起。
- ③ 按一下本机遥控器学习区的任一按键，本机遥控器白色背光快速闪烁一下。
- ④ 再按一下需要学习的遥控器上的功能按键，（本机遥控器收到信号后白色背光会快速闪烁两次）。
- ⑤ 如有多个按键功能需要学习，请重复第 3 第 4 步。
- ⑥ 学习完毕后，按下本机遥控器学习区外任一按键，即可退出学习模式，随后本机遥控器白色背光灯自动熄灭即学习完成。

## 设备连接

### 1. HDMI 连接电视

- ① 将设备断电，请务必保证电视机与机顶盒都在断电的状态下操作。

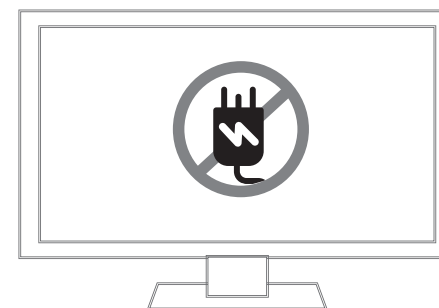

② 在 TV 断电的状态下将 HDMI 线一头插入设备的 HDMI OUT、一头插入电视 HDMI IN 接口。



③ 电源连接，本设备配备有 DC 电源适配器，请将 DC 适配器接头连接在本机的 DC 电源输入接口，将 DC 电源线的插头一端接入交流 110~240V 的电源插座。

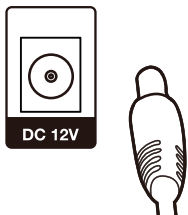

④ 电视选择对应的视频源。

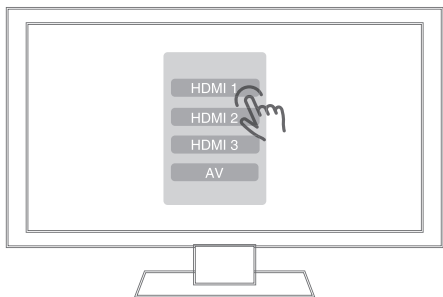

## 2. AV 线连接电视

连接方式同 HDMI 线的连接方式。

## 3. RS232 连接 3.5mm 插头连线顺序



## Z10 性能参数

材料	航空铝合金
前置显示	LED
机身	航空铝合金外壳
系统	Android + OpenWRT
CPU	Realtek RTD1296 ARM Cortex-A53 四核
GPU	ARM T820 MP3(3 核)
内存	2GB DDR
内部储存器	16GB eMMC
Wifi 连接	802.11AC MIMO 双频 WIFI
以太网网络	1*RJ-45 以太网插孔 (10/100 / 1000Mbps)
HDMI 输出	HDMI 2.0a, 支持 4K@60fps, HDR10
HDMI 输入	HDMI 2.0
视频解码	HDR, 10 位 HEVC/H.265 高达 4K@60fs, VP9 高达 4K@60fps, H.264 高达 4K@24fps
音频解码	支持高清音频多声道直通和立体声解码
硬盘仓	1*SATA 3.0
USB	2*USB 3.0, 2*USB 2.0
功率	DC 12V
其他接口	1* 红外接收器, 1*RCA 视频, 1*RCA 左右声道 1* 同轴, 1*SPDIF 光纤 (2CH, 5.1CH), 1*3.5 毫米 RS232, 2* 外部高增益天线, 1*SATA 3.0

# 初始化

正式使用机器前，本软件将为您进行第一次初始化设置，请根据初始化设置流程设置您的设备，以获得最佳的观影体验。

## 1. 系统语言

根据个人需要设置系统语言。



## 2. 屏幕缩放

通过遥控器左右键或鼠标中键滑轮调整屏幕显示范围到合适的大小。



## 3. 网络设置

设置相关网络配置，让机器快速连接网络。网络分为无线网络和有线网络，选择其中一种连接成功即可。



无线网络 (WIFI)：选择网络 SSID，输入密码，连接 WIFI 即可完成设置。  
有线网络：无需其他操作，只需插入网线即可自动联网。网络设置完成后点击下一步了解主界面功能即可完成整个设备的初始化。



# OTA 系统升级

芝杜 ZIDOO 会不定期更新固件。

在 APPS 应用中心找到系统升级图标点击打开；支持在线网络升级及本地升级两种方式；勾选自动检测最新版本后，您将会自动收到最新的系统升级提示。



## 1. 在线升级

点击“在线升级”选项，获取在线升级信息。

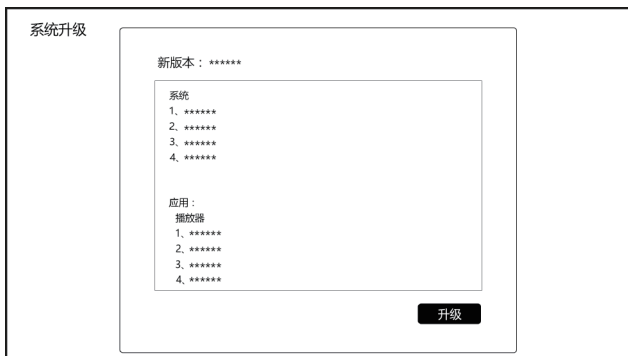

## 2. 本地升级

用户可通过在论坛或官网手动下载升级文件，通过本地升级的方式自行升级系统。

将下载好的升级文件拷贝到 U 盘，通过点击“本地升级”选项，选择升级文件。



通过在线升级或本地升级下载完升级文件后，通过点击“升级”选项，开始升级。

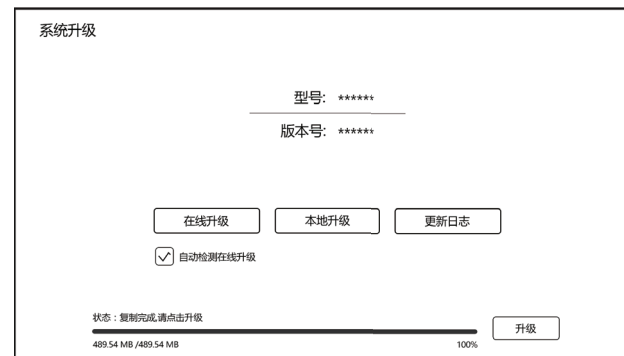

系统会自动检验升级文件是否完整。



升级完成, 自动重启系统。



注意: 自动进入系统升级, 该过程请不要断电。

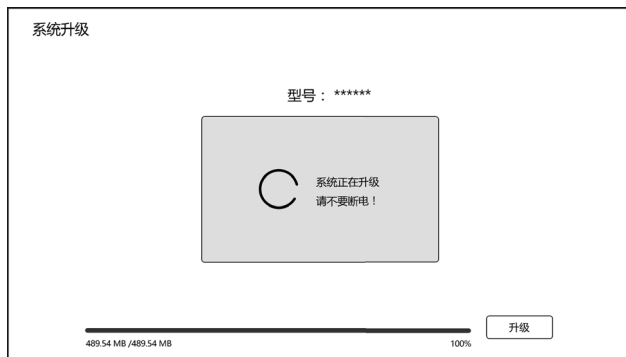

### 特别说明:

为了保证用户体验, 芝杜 ZIDOO 会不定期更新固件。因此, 本说明书的操作说明, 有可能会与产品实际使用情况稍有出入。



# Introduction to hardware of Z10

## Device interface

Zidoo Z10 is equipped with audio input & output ports and data transmission port. Please refer to the descriptions in this manual.

### 1. Front

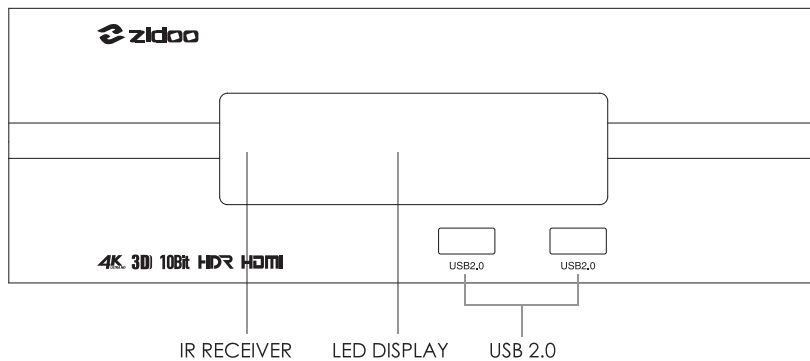

### 2. Right

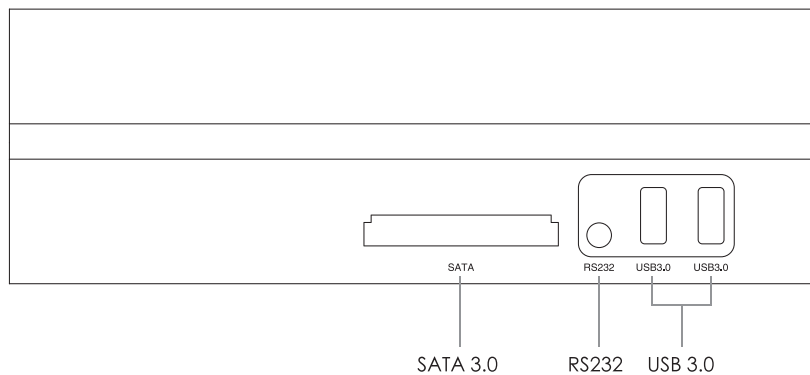

### 3. Left

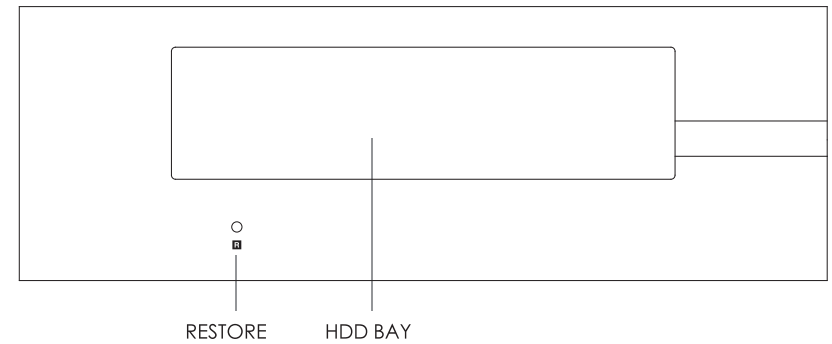

### 4. Back

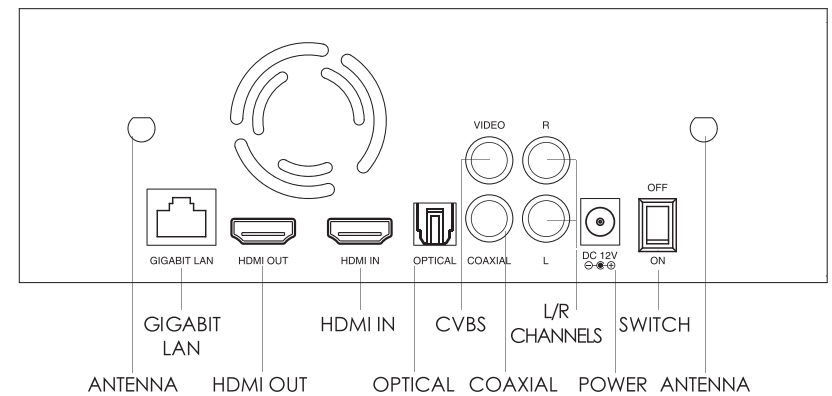

Instruction to installation of the antenna: Please insert the two antennas in the parcel into the antenna ports in the above diagram.

Note:

- \*Please load/change the hard disk after turning off the power. If it is a brand-new hard disk, Please load it after formatting it.
- \*Please prevent the orifice of the cooling fan from being blocked.
- \*Do not touch any liquid in case the liquid runs into the inner part of the device and damage it.
- \*Any maintenance personnel who are not appointed are not allowed to open the case.

## Load The Hard Disk

Z10 is equipped with hard disk storage of 3.5 inches and SATA high speed transmission port. The hard disk can be loaded by pushing in, with no other tools. (The maximum hard disk supports 10 TB )

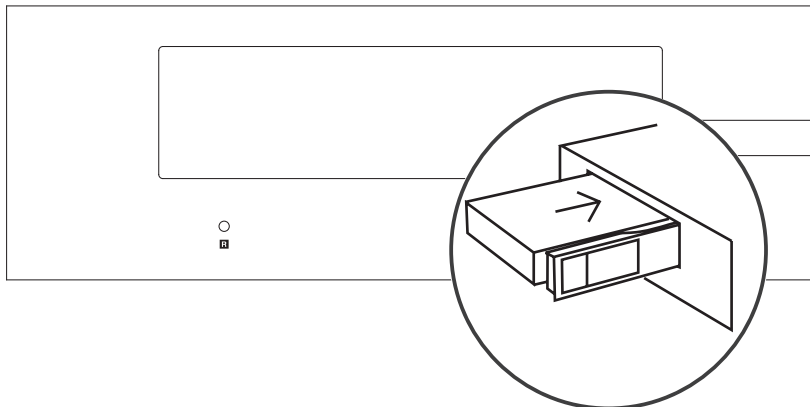

**Note:** Do not load or change the hard disk while the power is on to avoid that the device or the data of hard disk be damaged. If it is a brand-new hard disk, please format it before loading it to the device. This device support following formats of hard disk: EXT3, EXT4, NTFS, FAT32, EXFAT.

## Remote Control

### 1. Button Features Description

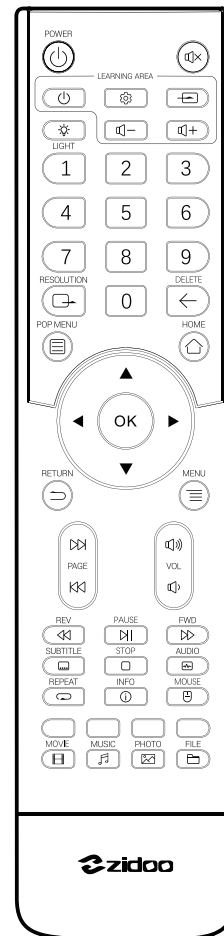

Functions	Buttons
Turn on/off	
TV Learning Area	
VOL+/VOL-/Mute	
Playback	
Mediainfo	
Pop Menu	
Page up/down	
Mouse	
Home	
Return	
Menu	
Resolution	
Light	
Delete	
Numbers	<b>1/2/3/4/5/6/7/8/9/0</b>
Multi-Function	
Shortcut	

## 2. Learning Button Introduction

Learning function: This remote control can copy functions of buttons from other remote control so that can control two devices.

Operation descriptions of Learning Button:

- 1) Point the top of this remote control to that of the remote control to be copied, align the infrared transmitting tubes.
- 2) Press  in the study area of this remote control until its white backlight is activated.
- 3) Press any button in the study area of this remote control, its white backlight flashes once.
- 4) Press the function button of the remote control to be copied. After the remote control receives the signal, the white backlight will quickly flash twice.
- 5) If there are many functions need to be learned, please repeat step 3 and 4.
- 6) After completing learning, press any buttons outside the learning area of this remote control to exit learning mode. Then the white backlight of this remote control will turn off automatically and completed learning.

## Device Connection

### 1. HDMI connects to the TV

1) Cut off the power of the device. Please make sure the power of the TV and STB at OFFS Model.

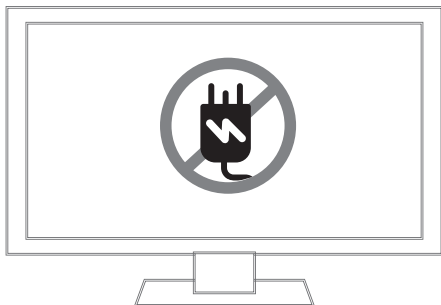

2) While the power of TV is turned off, insert one end of HDMI cable into HDMI OUT port and insert the other end into HDMI IN port.



3) Connect with the power. This device is equipped with suitable DC power adapter. Please connect the head of DC power adapter to the DC power input port of this device, then insert the plug of DC power line into the alternating current socket of 110V - 240V.



4) Corresponding video source is selected by TV.

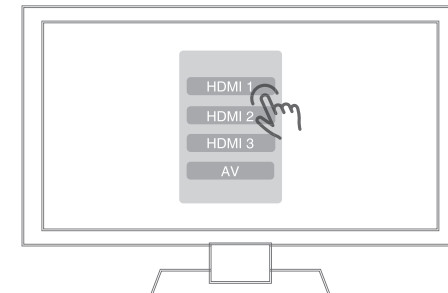

### 2. Connect AV cable with the TV

The connection method is same as connecting HDMI cable.

### 3. RS232 connect 3.5MM Connector Assembly Sequence



## Z10 Specification

<b>Material</b>	Aviation Aluminum Alloy
<b>Front Display</b>	LED
<b>Shell</b>	Aviation Aluminum Alloy Case
<b>OS</b>	Android + OpenWRT
<b>CPU</b>	Realtek RTD1296 ARM Cortex-A53 Quad-Core
<b>GPU</b>	ARM T820 MP3(3-Core)
<b>Memory</b>	2GB DDR
<b>Internal Storage</b>	16GB eMMC
<b>WIFI Connectivity</b>	802.11 AC MIMO Dual-Band WIFI
<b>Ethernet</b>	1*RJ-45 Ethernet Jack (10/100/1000Mbps)
<b>HDMI Out</b>	HDMI 2.0a, Support 4K@60fps, HDR10
<b>HDMI In</b>	HDMI 2.0
<b>Video Decoder</b>	HDR, 10-bit HEVC/H.265 up to 4K@60fp VP9 up to 4K@60fps, H.264 up to 4K@24fps
<b>Audio Decoder</b>	Support HD audio multichannel direct access and stereo decoding
<b>HDD Bay</b>	1*SATA 3.0
<b>USB</b>	2*USB 3.0, 2*USB 2.0
<b>Power</b>	DC 12V
<b>Other interface</b>	1*IR Receiver, 1*RCA Cvbs, 1*RCA Audio L/R Channels, 1*Coaxial, 1*SPDIF(2CH, 5.1CH), 1*3.5mm RS232, 2*External High-Gain Antenna, 1*SATA 3.0

## Initialization

Before actually using this device, you will be provided with this software for the first initialization. Please set your device according to the initialization process to obtain the optimum watching experience.

### 1. System Language

Select the language of the system as you want.



### 2. Screen Scaling

Adjust the screen display range using LEFT or RIGHT button of the remote control ( Mouse Wheel ) so that the image can be appropriately displayed on the screen of the TV.

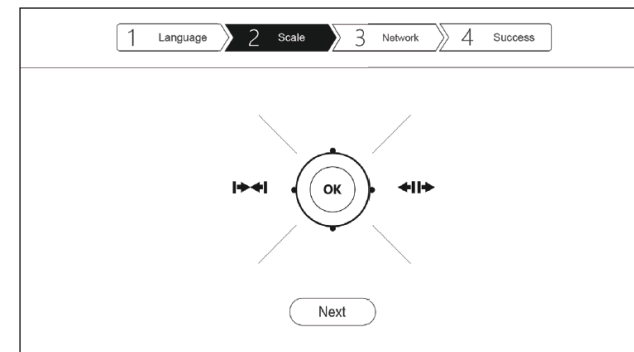

### 3. Network Setting

Set the configuration of the network so that the device can quickly connect with the network. The network is including WIFI network and Ethernet network. Select either of them and successfully connect with it.

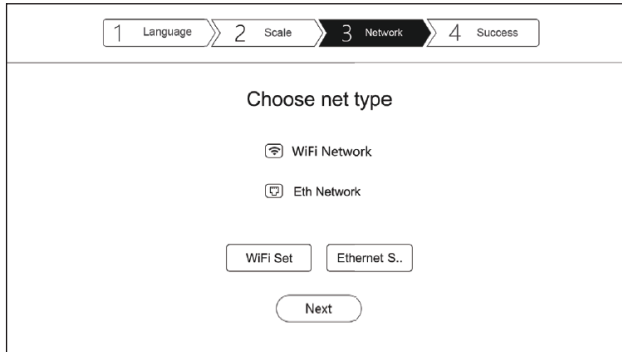

**WIFI:** Select SSID and enter password, connect to WIFI and finish setting.

**Ethernet Network:** No other operation needed except that inserting cable and then automatically connect to internet. After completed the Internet setting, please click "NEXT" to further steps and get to know the function of the Home Page and finish initialization.

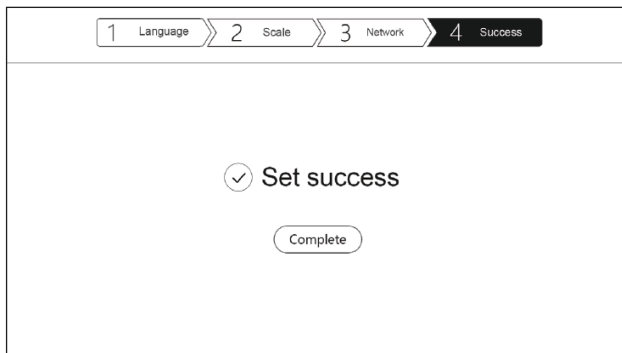

### System update by OTA

Zidoo will update the firmware aperiodicity. Find the system update icon in APP center and open it; Support online network update and local update; After ticking "Automatically detect the latest version", you will receive the prompt for the latest firmware update automatically.

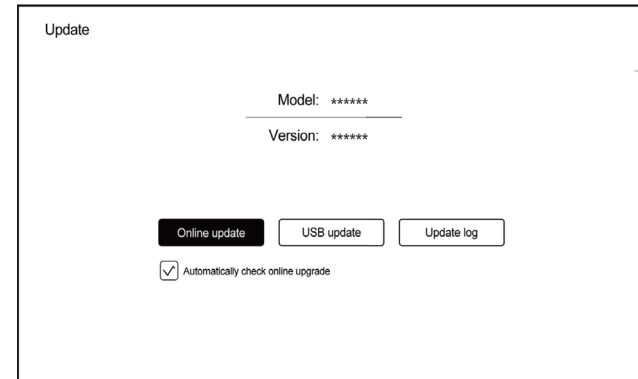

#### 1. Online Update

Click "Online Update" to obtain information of online update.

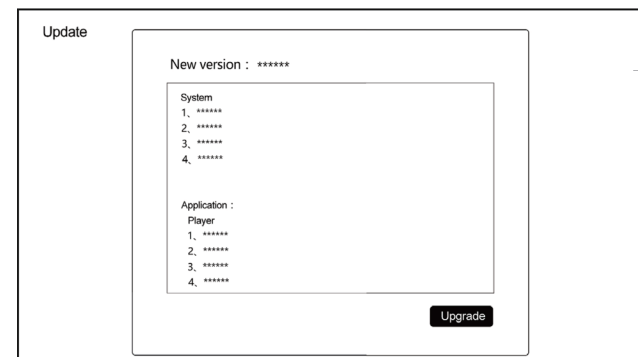

## 2. Local Update

Users can download the update files on the forum or official website and update firmware through files.

Copy the downloaded update files to USB disk. Click "USB update" to select the update files.

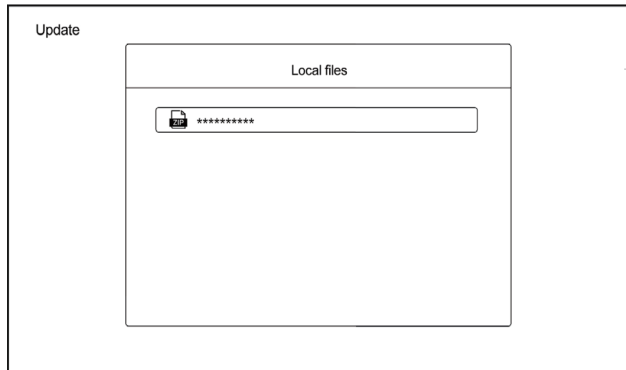

Download the update files by online update or local update. Click "Update" to update.

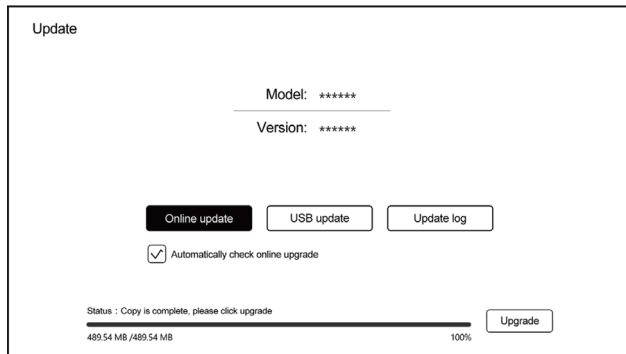

The system will automatically check the update files whether is complete or not.

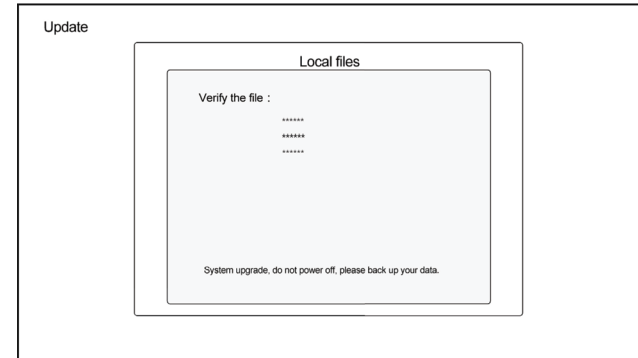

Note: Automatically access to system upgrade. Please don't power off in the progress.

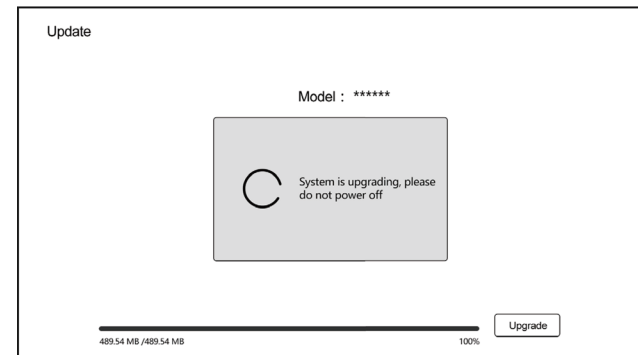

Once the update is completed, the system will automatically be restarted.



**Special Note:**

To guarantee user experience, Zidoo will update the firmware aperiodicity. Therefore, this manual may not be totally in line with the product.