

感谢您使用芝杜 zidoo 旗下产品，您可以关注我们的社交平台账号，和我们一起交流与分享。

Thank you for choosing products of Zidoo. Friend us on WeChat or Weibo to communicate and share with us.



微信公众号 @ zidoo
WeChat Official Account



微博账号 @ 芝杜官方
Weibo Account



Facebook @ zidootv



Twitter @ zidootv

如需更多帮助，请访问芝杜 zidoo 官网的用户论坛进行咨询

If you need more assists, please visit user forum of the official website of Zidoo for consultation.



官网网址 /Official website: www.zidoo.tv

目录 / CONTENT

01	X20 PRO/ X20 硬件介绍	
	X20 PRO 设备接口	P1
	X20 PRO 性能参数	P2
	X20 设备接口	P3
	X20 性能参数	P4
	硬盘装载	P5
	遥控器	P6
	设备连接	P7
02	HDMI 和声音处理	P10
03	初始化	P13
04	OTA 系统升级	P16

01	Introduction of X20 PRO/X20 Hardware	
	X20 PRO Device interface	P20
	X20 PRO Performance parameters	P21
	X20 Device interface	P22
	X20 Performance parameters	P23
	Device Interface	P24
	Remote Control	P25
	Device Connection	P26

02	HDMI & Audio Processing	P29
03	Initialization	P32
04	OTA Updating	P35

X20 PRO 硬件介绍

设备接口

Zidoo X20 PRO 配备有丰富的音视频输入输出接口及数据传输接口，请参考本手册内容。

1 正面

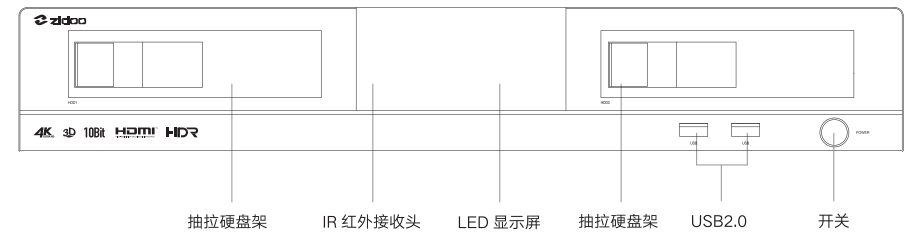

2 背面

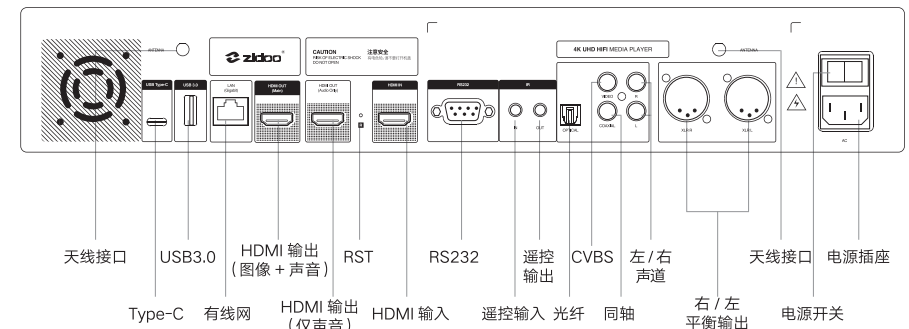

天线安装说明：请将附件中的两根天线安装至上图所示的天线接口。

注意：

- * 请在断电情况装载 \ 更换硬盘，如是全新硬盘，请格式化后装载。
- * 请不要将任何东西遮挡散热风扇孔。
- * 请不要接触液体，以免流入设备内部造成损坏。
- * 非指定维修人员，请不要拆开机壳。

X20 PRO 性能参数

材料	太空铝
显示屏	LED 显示屏
外壳	航空铝合金外壳
系统	Android+ OpenWRT(NAS) 双系统同时运行
CPU	Realtek RTD1296 ARM Cortex-A53 四核
GPU	ARM T820 MP3(3 核)
内存	4GB DDR4
内部储存器	32GB eMMC
Wi 连接	802.11AC MIMO 2T2R 867Mbps
以太网网络	1*RJ-45(10/100/1000Mbps)
蓝牙	BT4.1
HDMI2.0a 主口 / HDMI1.4 副口	音画分离输出 支持 4K@60fps 10Bit 输出
HDMI2.0 输入	最高支持 4K60 的 HDMI 输入
视频解码	支持 HDR10, 最高支持 4K H.265 10Bbit 解码
视频播放	支持 4K 超高清, 支持自动切换帧率 支持 MVC 3D 播放功能, 支持字幕下载功能, 支持 ASS/SSA 特效字幕, 媒体中心功能
音频解码	支持高清音频透传和解码立体声输出, 内置 ESS 9038 DAC 音频解码
音频接口	1* 光纤输出、1* 同轴输出、1*XLR 左右声道输出 1*RCA 左右声道
模拟音频特性	信噪比 (SNR): >120dBra; 总谐波失真 + 噪音 (THD+N): < 0.0003%; 输出电平: (XLR) 4.5±0.4Vrms. (RCA) 2.2±0.2Vrms; 动态范围 (DNR): 122dB; 通道分离度 (Crosstalk): >128dBra
USB	1*USB3.0、2*USB2.0、1*TYPE-C
内置硬盘仓	支持 SATA3.0*2 双硬盘内置 (不含硬盘)
输入	100-240V-50/60Hz Max 1.3A
其他接口	1*RS232、1* 红外输出、1* 红外输入

X20 硬件介绍

设备接口

Zidoo X20 配备有丰富的音视频输入输出接口及数据传输接口, 请参考本手册内容。

1 正面

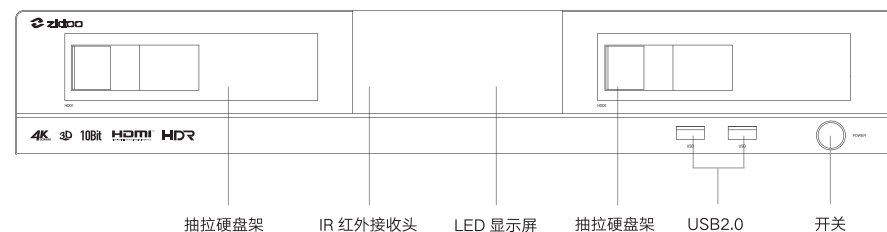

2 背面

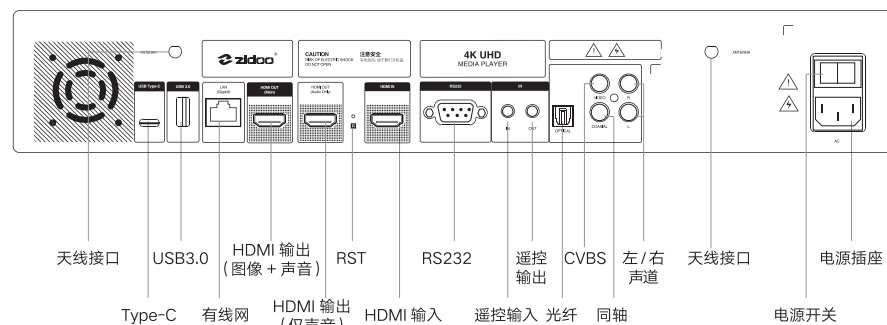

天线安装说明: 请将附件中的两根天线安装至上图所示的天线接口。

注意:

- * 请在断电情况装载\更换硬盘, 如是全新硬盘, 请格式化后装载。
- * 请不要将任何东西遮挡散热风扇孔。
- * 请不要接触液体, 以免流入设备内部造成损坏。
- * 非指定维修人员, 请不要拆开机壳。

X20 性能参数

材料	太空铝
显示屏	LED 显示屏
外壳	航空铝合金外壳
系统	Android+OpenWRT(NAS) 双系统同时运行
CPU	Realtek RTD1296 ARM Cortex-A53 四核
GPU	ARM T820 MP3(3 核)
内存	2GB DDR4
内部储存器	16GB eMMC
Wifi 连接	802.11AC MIMO 2T2R 867Mbps
以太网网络	1*RJ-45 (10/100/1000Mbps)
蓝牙	BT4.1
HDMI2.0a 主口 / HDMI 1.4 副口	音画分离输出 支持 4K@60fps 10Bit 输出
HDMI2.0 输入	最高支持 4K60 的 HDMI 输入
视频解码	支持 HDR10, 最高支持 4K H.265 10Bbit 解码
视频播放	支持 4K 超高清, 支持自动切换帧率, 支持 MVC 3D 播放功能, 支持字幕下载功能, 支持 ASS/SSA 特效字幕, 媒体中心功能
音频解码	支持高清音频透传和解码立体声输出
音频接口	1* 光纤输出、1* 同轴输出、1*RCA 左右声道
USB	1*USB3.0; 2*USB2.0; 1*TYPE C
内置硬盘仓	支持 SATA 3.0*2 双硬盘内置 (不含硬盘)
输入	100-240V~50/60Hz Max 1.3A
其他接口	1*RS232、1* 红外输出、1* 红外输入

装载硬盘

X20 PRO /X20 搭载两个 3.5 寸硬盘仓，内置 SATA 高速传输接口，无需借助任何工具，将 3.5 寸硬盘有 SATA 接口的那一头朝向硬盘仓，轻轻推入即可装载成功。（硬盘最大支持 10TB）

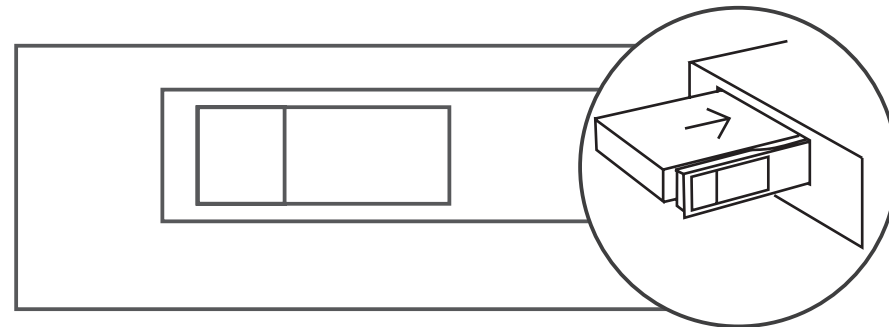

注意：请勿在设备通电情况下装载或更换硬盘，以免造成设备或硬盘数据损坏，如果是全新硬盘，请先格式化硬盘再装载至设备，本机支持硬盘格式为：:EXT3,EXT4,NTFS,FAT32,EXFAT。

遥控器

1 键位功能描述

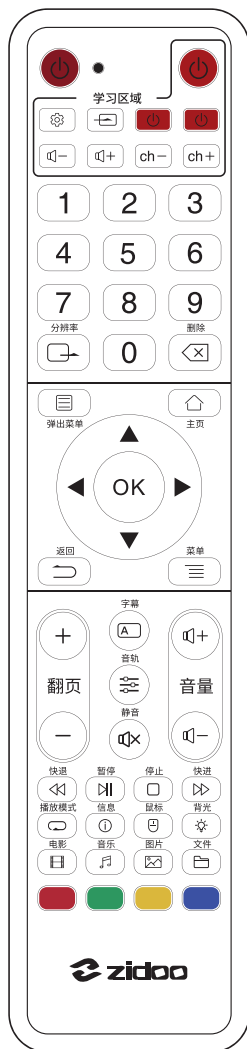

功能	按键
开关	
学习区域	
数字键	1/2/3/4/5/6/7/8/9/0
分辨率	
删除	
弹出菜单	
主页	
返回	
菜单	
字幕	
音轨	
声音 +/ 声音 -/ 静音	
上下翻页	+ -
快退 / 暂停 / 停止 / 快进	
播放模式 / 信息 / 鼠标 / 背光	
电影 / 音乐 / 图片 / 文件	
功能键	

2 学习键介绍

此款遥控器的学习功能可以将其它遥控器的某些按键功能复制到本遥控器上来，用一个遥控器即可完成两个设备的操控。

学习键的操作说明：

- 1) 按住 键 3 秒左右，直到指示灯长亮；
- 2) 按一次需要学习的按键，此时指示灯闪烁；
- 3) 将两个遥控器红外发射窗保持 3 厘米左右的距离，然后按一次其它遥控需要学习的功能键。如果学习成功，指示灯停止闪烁，依此类推学习其它的学习键，学习完成后按 键退出学习模式；
- 4) 按背光键可以开关背光。

3 蓝牙配对

遥控器对准机器，距离 30 厘米以内，同时按住翻页下键与菜单键 5 秒至指示灯闪烁，进行配对，配对完成之后指示灯熄灭。

设备连接

1HDMI 连接电视

X20 PRO /X20 拥有两种 HDMI 连接方式，一种是单口输出，另一种是双口输出，请参考以下步骤进行连接。

- 1) 将设备断电，请务必保证电视机与机顶盒都在断电的情况下操作；

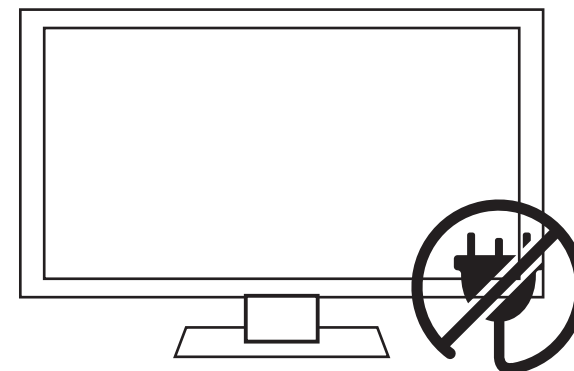

2) 单口输出: 在电视机与机顶盒都断电的情况下, 将 HDMI 线一头插入设备的 HDMI OUT MAIN 接口、另一头插入电视 HDMI IN 接口;

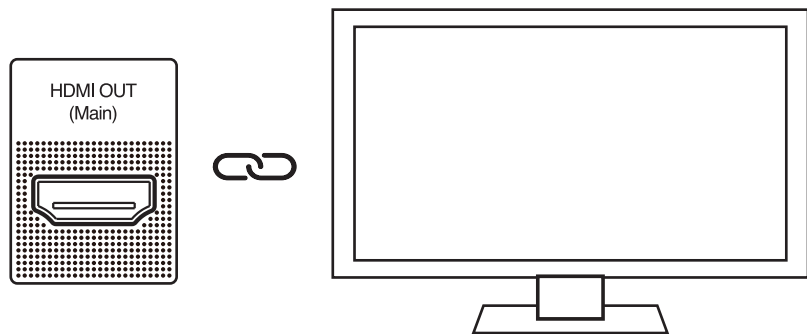

3) 双口输出 (显示画面和声音分开输出): 在电视机与机顶盒都断电的情况下, 将 HDMI 线一头插入设备的 HDMI OUT AUDIO ONLY 接口、另一头接入功放; 再用另一根 HDMI 线一头插入设备的 HDMI OUT MAIN 接口, 另一头接入电视 HDMI IN 接口, 即可实现音画分离输出; (双口输出方式适合功放设备不支持 4K 或 3D 功能, 显示设备支持 4K 或 3D 功能时使用。)

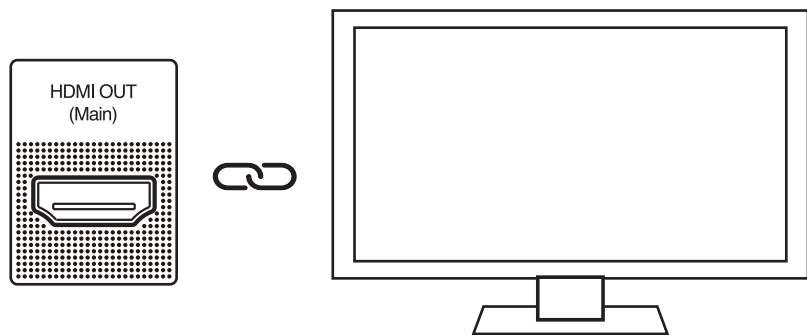
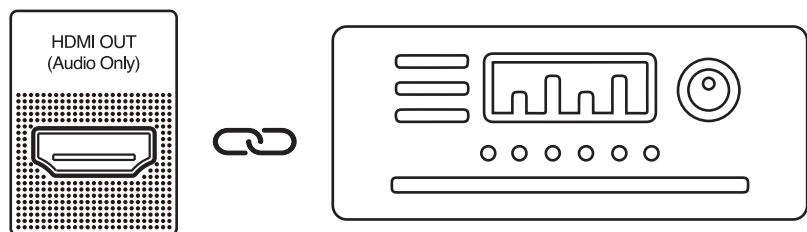

4) 电源连接: 本设备内置电源, 请将随机附赠的电源线加入本机的 AC 电源插座, 将电源线的另一头接入交流 110~240V 的电源插座后, 打开 AC 电源插座上的电源开关;

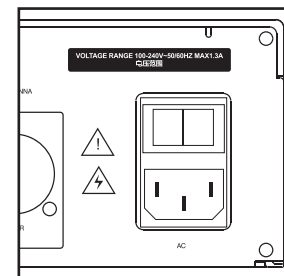

5) 按下机器前面板右下角的开机按钮或按下遥控器电源键进行开机, 并打开电视机;

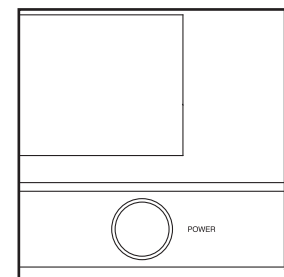

6) 电视选择对应的视频源。

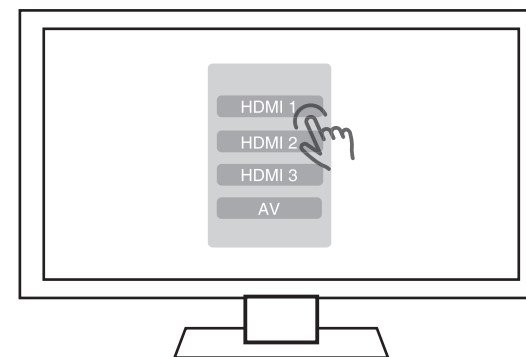

2 其它连接方式

其它连接方式同 HDMI 线的连接步骤, 请先将线路连接好再通电。

HDMI 和声音处理

1 HDMI 输出设置

如果采用双 HDMI 输出模式，即 HDMI 主口接入电视或者投影，副口接入功放。有三种模式可以设置。

- 1) 主副口分离模式：视频从主口输出，音频从副口输出，实现音画分离（默认）；
- 2) 主口 + 副口模式：主口会输出音频和视频，副口会输出音频；
- 3) 主口模式：主口输出音频和视频，副口不输出音频



2 模拟声音处理（此项设置只针对 X20 PRO。X20 没有此项设置）

1) 模拟声音开关

如果需要模拟声音输出，需打开此项开关。打开此项开关，HDMI 声音输出会自动的设置为解码立体声。同理，如果 HDMI 声音设置成源码输出或者自动输出，此开关会自动关闭。

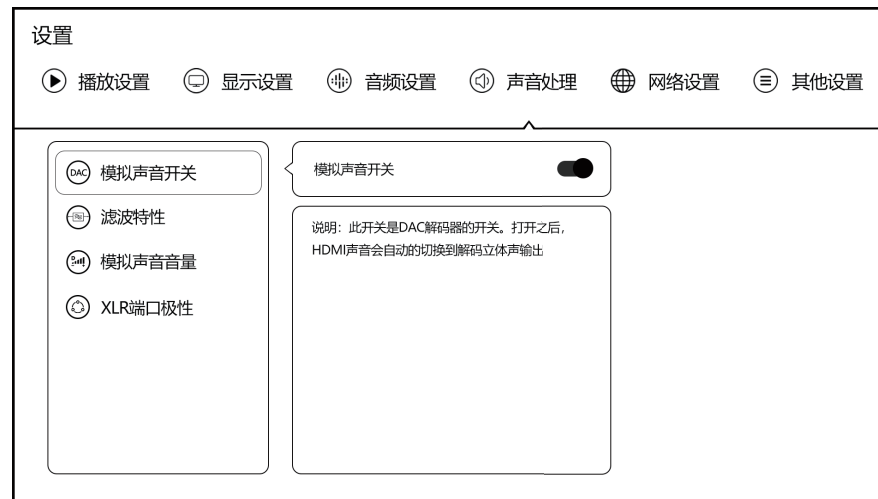

2) 滤波特性



3) 模拟声音音量

此音量设置只针对 DAC 解码器，声音数值是 DAC 解码器的音量数值。



4) XLR 端口极性

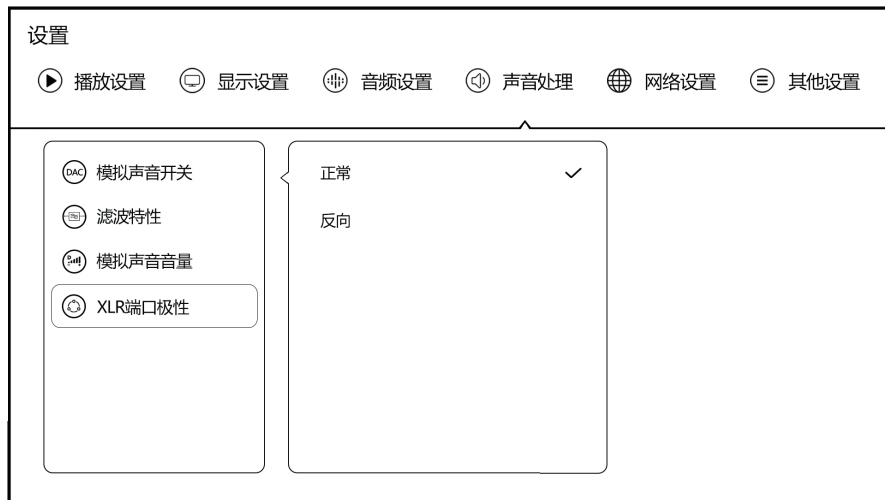

初始化

正式使用机器前, 请根据初始化流程设置您的设备, 以获得最佳的观影体验。

1 系统语言

根据个人需要选择系统需要显示的语言。



2 蓝牙遥控配对

遥控器对准机器, 距离 30 厘米以内, 同时按住翻页下键与菜单键 5 秒至指示灯闪烁, 进行配对, 配对完成之后指示灯熄灭。



配对详情

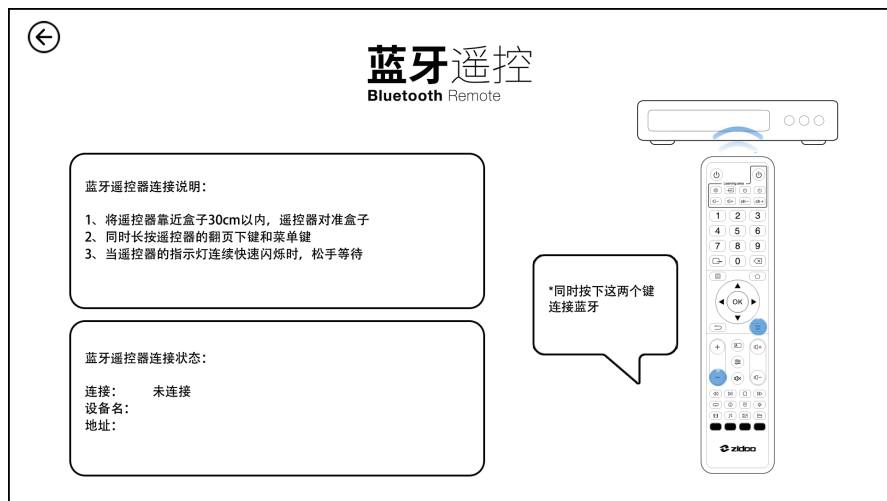

3 屏幕缩放

通过遥控器左右键或鼠标中键滑轮调整屏幕显示范围到合适的大小。

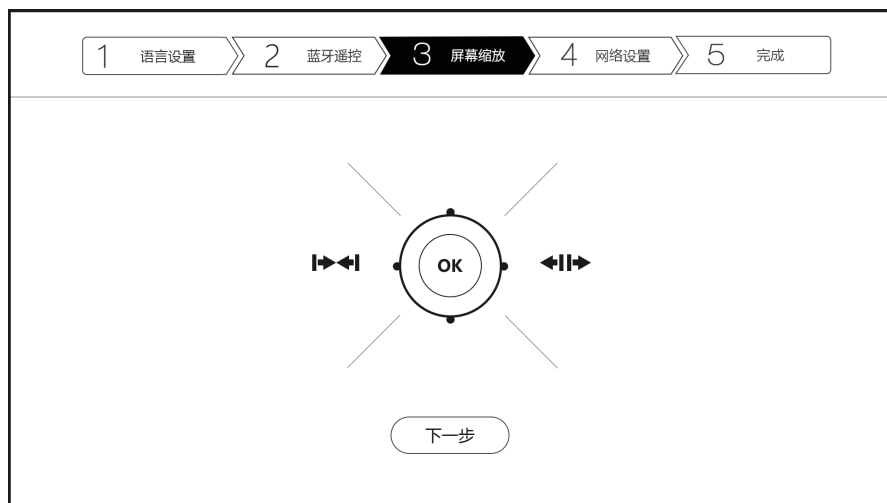

4 网络设置

设置相关网络配置，让机器快速连接网络。网络分为无线网络和有线网络，选择其中一种连接成功即可。



无线网络 (WIFI)：选择网络 SSID，输入密码，连接 WIFI 即可完成设置；



有线网络：无需其他操作，只需插入网线即可自动联网。随后点击下一步即可完成初始化操作。

OTA 系统升级

芝杜 ZIDOO 会不定期更新固件。

在应用中心找到系统升级图标点击打开；支持在线网络升级与本地升级两种方式；勾选自动检测在线升级后，您将会自动收到最新的系统升级提示。



1 在线升级

点击“在线升级”选项，获取在线升级信息后即可进行升级。

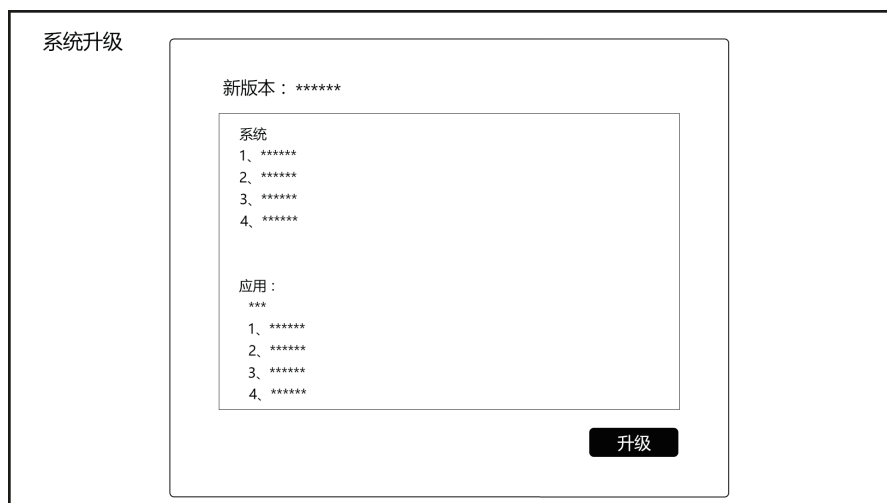

2 本地升级

用户可通过在论坛或官网手动下载升级文件，通过本地升级的方式自行升级系统。

将下载好的升级文件拷贝到U盘，通过点击“本地升级”选项，选择升级文件。



通过在线升级或本地升级下载完升级文件后，点击“升级”选项，开始升级。

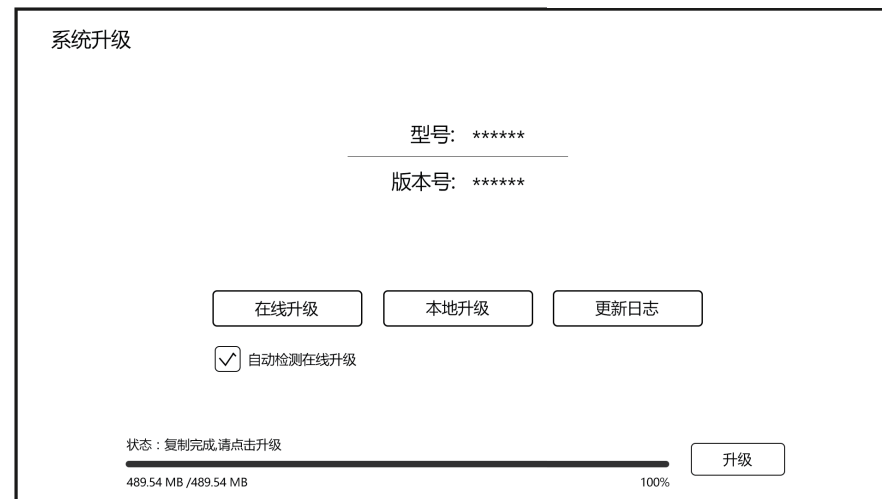

开始升级后，系统会自动检验升级文件是否完整。



升级完成，自动重启系统。



注意：自动进入系统升级，该过程请不要断电。

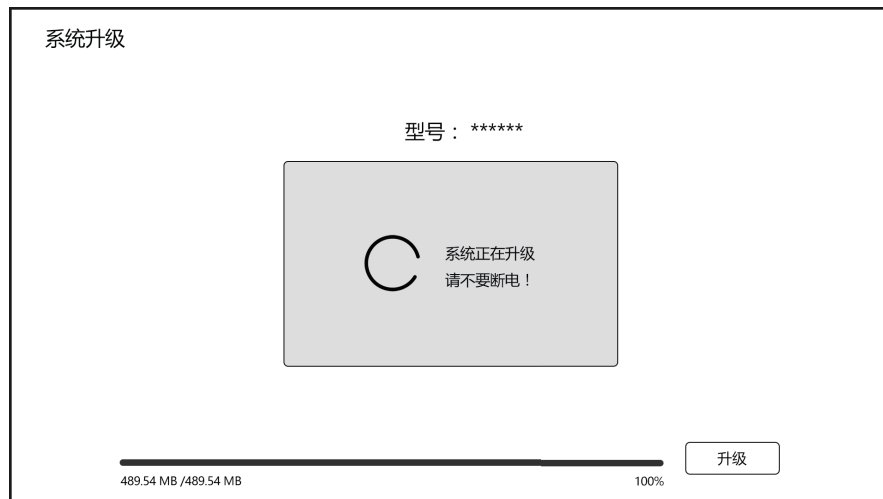

特别说明：

为了保证用户体验，芝杜 ZIDOO 会不定期更新固件，因此，本说明书的操作说明，有可能会与产品实际使用情况稍有出入，请以实际情况为准。

安全警示：

- 1、本设备不得遭受水溅或水滴，不得在设备上放置类似花瓶一类装满液体的物品。
- 2、本产品断开装置为输入插座，配备给本产品使用的插座应当装在本产品附近，且应当便于操作，不能被其他物体阻挡。
- 3、本产品为 I 类设备，使用时机箱内部必须要有接地措施。

INTRODUCTION TO HARDWARE OF X20 PRO

Device interface

Zidoo X20PRO is equipped with audio input and output ports and data transmission port. Please refer to the descriptions in this manual.

1.Front

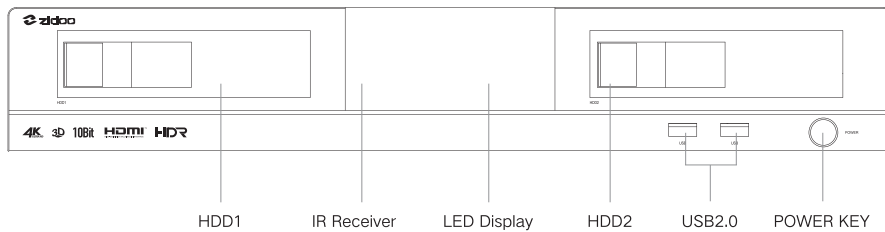

2.Back

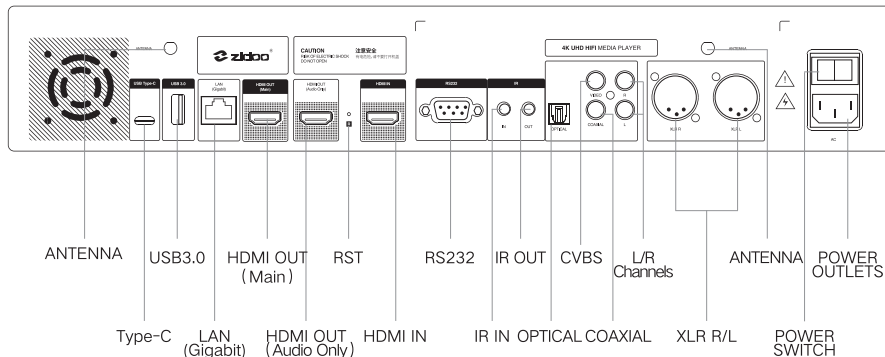

Instruction to installation of the antenna: Please insert the two antennas in the parcel into the antenna ports in the above diagram.

Notices:

- *Please load/change the hard disk after turning off the power. If it is a brand-new hard disk, please load it after formatting it.
- *Please prevent the orifice of the cooling fan from being blocked.
- *Do not touch any liquid in case the liquid runs into the inner part of the device and damages it.
- *Any maintenance personnel who are not appointed are not allowed to open the case.

X20 PRO PERFORMANCE PARAMETER

Material	Space Aluminium
Display	LED Display
Material	Aviation Aluminum alloy case
OS	Android + OpenWRT(NAS) dual system run simultaneously
CPU	RTD1296 ARM Cortex-A53 Quad-Core
GPU	ARM T820 MP3(3-core)
Memory	4GB DDR4
Internal Storage	32GB eMMC
Wifi Connectivity	IEEE 802.11a/b/g/n/ac 2*2 MIMO
Ethernet	1*RJ-45 (10/100/1000Mbps)
Bluetooth	BT4.1
HDMI2.0a Main Output/ HDMI1.4Second Output	Audio and video separation output ; Support 4K@60fps 10Bit
HDMI Input/ HDMI2.0	Support 4K60 HDMI
Video Decode	HDR , Support 4K H.265 10Bbit
Video Player	Support 4K UHD; auto frame-rate switch; 3D Play; Subtitle Download; ASS/SSA effect Subtitle; Media center
Audio Decode	Support HD audio decode and pass through Redesigned Native Player
Audio Interface	1* Composite video output; 1*coaxial output; 1*SPDIF output; 1*XLR Left and right channels audio output; 1*RCA Left and right channels audio output
Analog audio characteristics	Signal to noise ratio (SNR):>120dBra; Total harmonic distortion + Noise (THD+N): < 0.0003%; Output Level:(XLR)4.5±0.4Vrms. (RCA)2.2±0.2Vrms; Dynamic Range(DNR):122dB; channel separation or Crosstalk(Crosstalk):>128dBra
USB	1*USB3.0; 2*USB2.0; 1*TYPE C
HDD BAY	Support SATA 3.0*2
Input	100-240V-50/60Hz Max 1.3A
Others	1*RS232; 1*IR Output; 1*IR Input

INTRODUCTION TO HARDWARE OF X20

Device interface

Zidoo X20 is equipped with audio input and output ports and data transmission port. Please refer to the descriptions in this manual.

1.Front

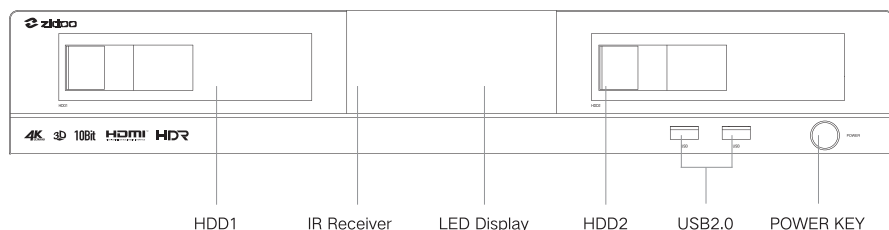

2.Back

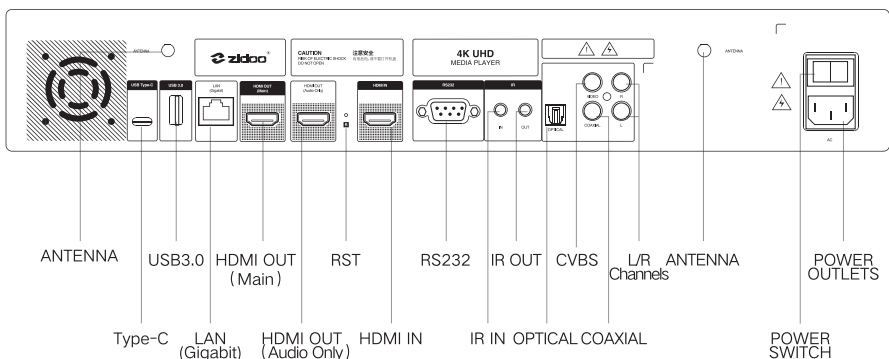

Instruction to installation of the antenna: Please insert the two antennas in the parcel into the antenna ports in the above diagram.

Notices:

- *Please load/change the hard disk after turning off the power. If it is a brand-new hard disk, please load it after formatting it.
- *Please prevent the orifice of the cooling fan from being blocked.
- *Do not touch any liquid in case the liquid runs into the inner part of the device and damages it.
- *Any maintenance personnel who are not appointed are not allowed to open the case.

X20 PERFORMANCE PARAMETER

Material	Space Aluminium
Display	LED Display
Material	Aviation Aluminum alloy case
OS	Android + OpenWRT(NAS) dual system run simultaneously
CPU	RTD1296 ARM Cortex-A53 Quad-Core
GPU	ARM T820 MP3(3-core)
Memory	2GB DDR4
Internal Storage	16GB eMMC
Wifi Connectivity	IEEE 802.11a/b/g/n/ac 2*2 MIMO
Ethernet	1*RJ-45 (10/100/1000Mbps)
Bluetooth	BT4.1
HDMI2.0a Main output/ HDMI1.4Second Output	Audio and video separation output ; Support 4K@60fps 10Bit
HDMI Input/ HDMI2.0	Support 4K60 HDMI
Video Decode	HDR , Support 4K H.265 10Bbit
Video Player	Support 4K UHD; auto frame-rate switch; 3D Play; Subtitle Download; ASS/SSA effect Subtitle; Media center
Audio Decode	Support HD audio decode and pass through Redesigned Native Player
Audio Interface	1* Composite video output; 1*coaxial output; 1*SPDIF output; 1*RCA Left and right channels output
USB	1*USB3.0; 2*USB2.0; 1*TYPE C
HDD BAY	Support SATA 3.0*2
Input	100-240V-50/60Hz Max 1.3A
Others	1*RS232; 1*IR Output; 1*IR Input

LOADING HARD DISK

X20 PRO/X20 with two 3.5 inches HDD. SATA high-speed device coffret. Please slowly push 3.5 inches hard disk with SATA interface toward HDD without any tools (Hard Disk support 10TB Maximum)

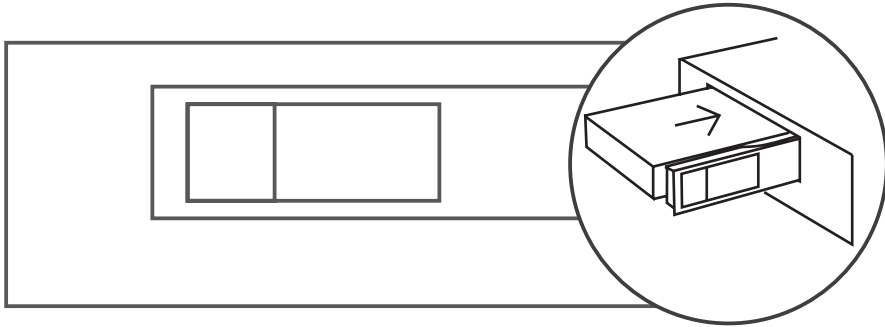

Notice:
Please do not loading or changing the Hard Disk when the power on and in order to avoid damage the Disk and Data. This device support filesystem :EXT3,EXT4,NTFS,FAT32,EXFAT.

REMOTE CONTROL

1.Description of functions of buttons

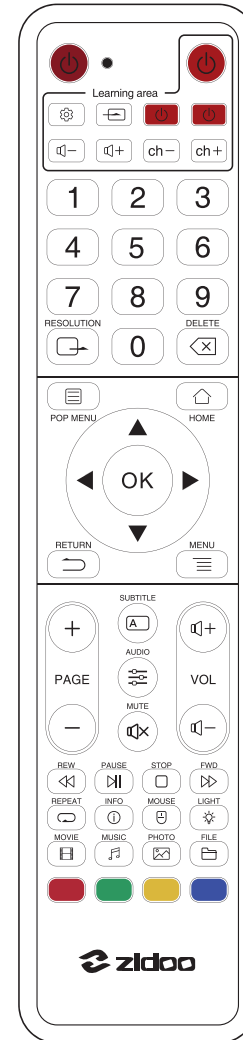



FUNCTIONS	KEYS
Power	
LEARNING AREA	
NUMBERS	1/2/3/4/5/6/7/8/9/0
RESOLUTION	
DELETE	
POP MENU	
HOME	
RETURN	
MENU	
SUBITITLE	
AUDIO	
VOL+/VOL-/MUTE	
PAGE+/PAGE-	+ -
REW/PAUSE/STOP/FWD	
REPEAT/INFO/MOUSE/LIGHT	
MOVIE/MUSIC/PHOTO/FILE	
FUNCTION KEYS	

2.Introduction to Learning button

Learning function: This remote control can copy functions of buttons of other remote control so that it can control two devices.

Operation descriptions of Learning button:

- 1) 1. Press  KEY for 3 sec until indicator light Always-On;
- 2) Press Learning KEY when indicator light blinking;
- 3) Let two remote controller Infrared emission windows with approximately 3cm distance, then press other remote controller Learning KEY. If learning progress works, indicator light stop blinking, by the analogy, apply to other Learning KEY, Press  KEY to exit the learning model.
- 4) Press Light KEY to turn on/off Backlight.

3. Bluetooth Pairing

Control remote is aimed at the machine within 30cm. Meantime press Down Key and Menu Key for least 5s until the indicator light blinking which pairing succeed.

Connection with Device

1.HDMI connects to the TV.

X20 PRO/X20 have two ways to connect HDMI. One is stand-up output mode and another one is Double output mode.

- 1) Cut off the power of the device. Please make sure the power of both the TV and Media Player are off.

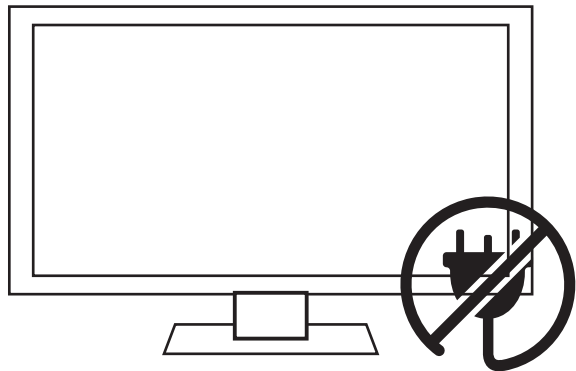

- 2) Stand-up Output mode: While the power of TV and Media Player is off, insert one end of HDMI cable into HDMI OUT and insert the other end into HDMI IN port.

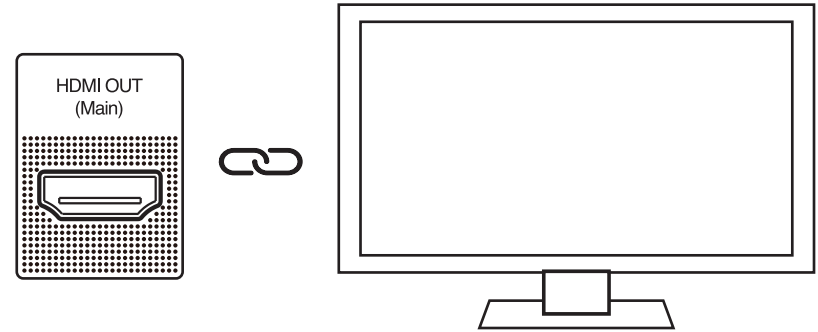

- 3) Double Output mode (The video is separated from the audio): While the power of TV and Media Player is off, make the connection between one side of HDMI cable with HDMI OUT AUDIO ONLY interface. Another side with amplifier.

Then use another HDMI cable connect with HDMI OUT MAIN interface. Another side with TV HDMI IN interface.

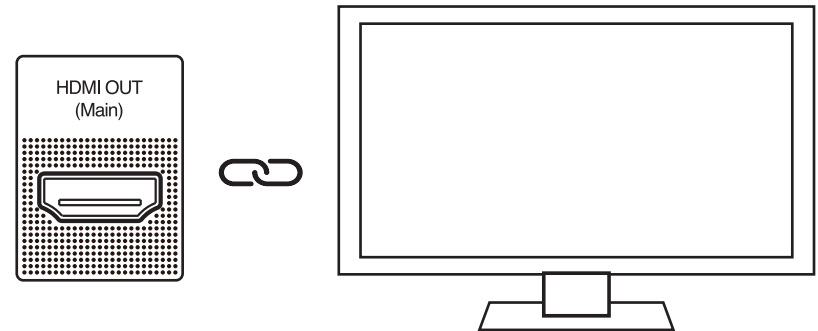
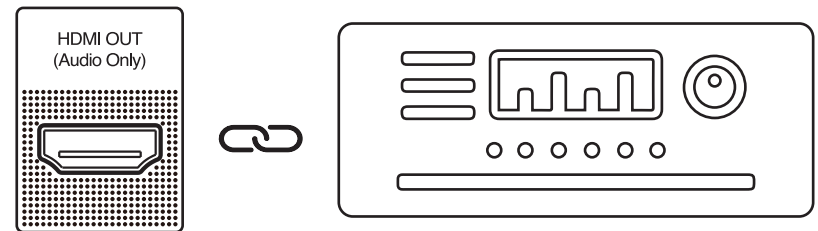

4) Connect with the power. This device is equipped with suitable AC power adapter. Please connect the head of AC power adapter to the AC power input port of this device, then insert the plug of AC power line into the alternating current socket of 110V -240V.

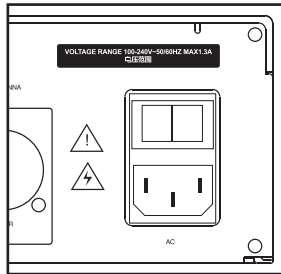

5) Press the right bottom side button or the power button on the remote control to turn on, then turn on the TV.

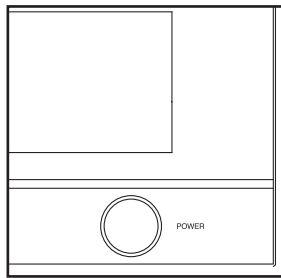

6) Corresponding video source is selected by TV.

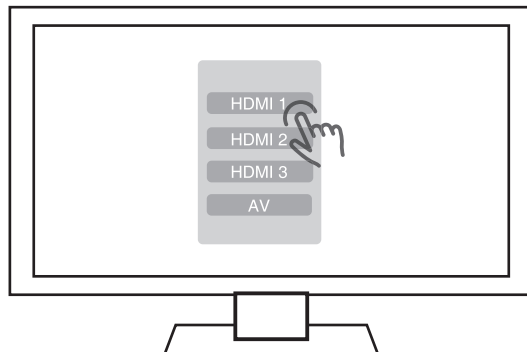

2.Connect AV cable with the TV

The connection method is same as that of HDMI cable. Please connect the AV cable before energizing.

HDMI & AUDIO PROCESSING

1. HDMI Output Setting

If apply double HDMI output mode which the main port access to TV or Projection, deputy port with power amplifier. Three mode to choose.

- 1) Master Port and Subport Separation Model: Video is outputting from main port, audio is outputting from deputy port and achieve Great Separation.
- 2) Master Port + Subport Model: Main port is outputting voice and video, deputy port is outputting audio.
- 3) Master Port Mode: Main port outputting audio and video, deputy port without audio.

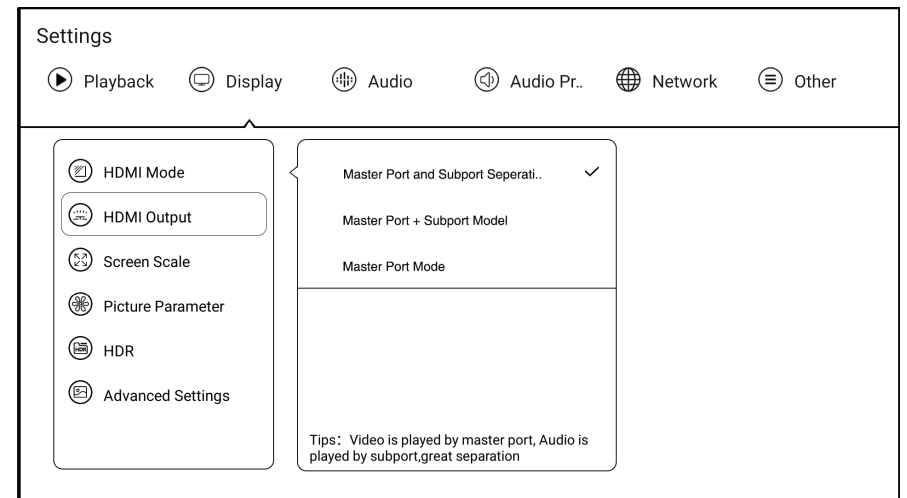

2. Analog Audio Processing(Only for X20 PRO)

1) Switch of analog audio

If you need to analog output, you must turn on the button. When you turn it on, HDMI audio output setting will automatic decode stereo. In the same way, If set HDMI audio output to passthrough output or auto-output, the switch will automatic turn off.

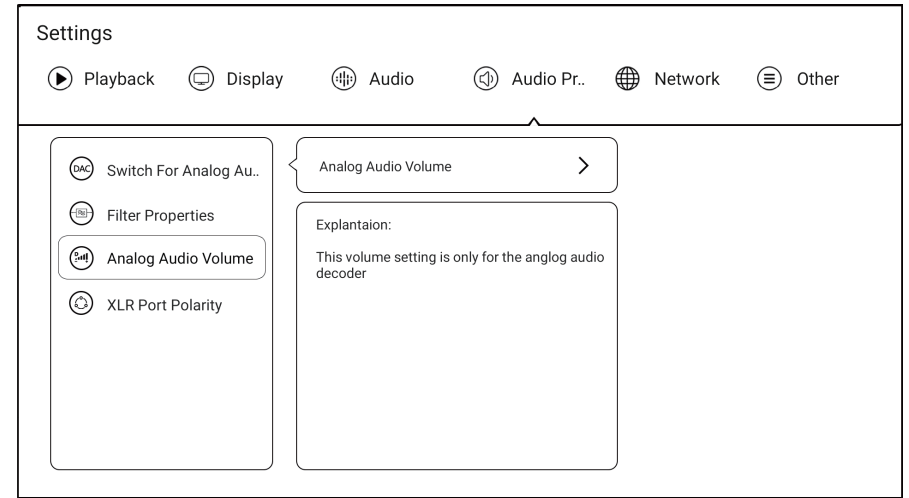
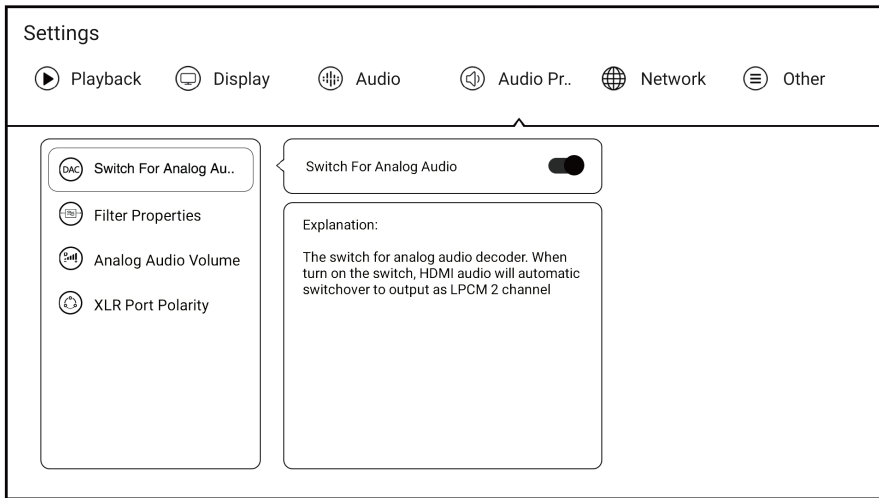

2) Filtering Features

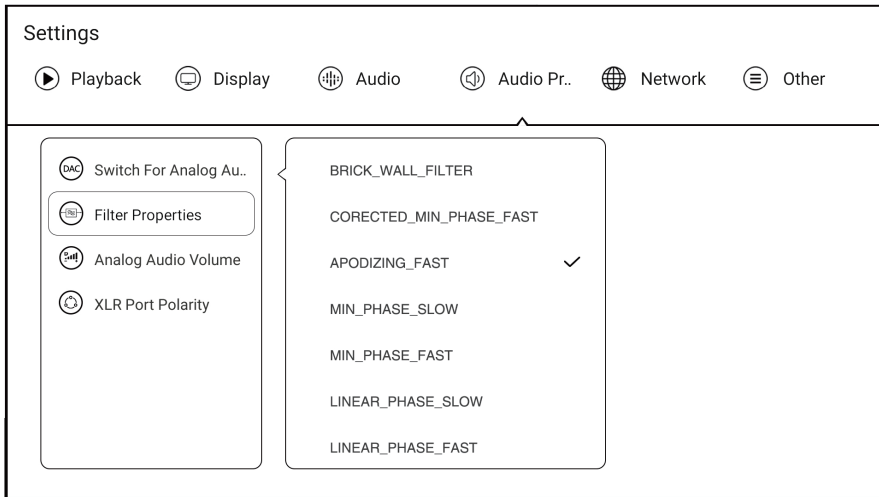

4)XLR Port polarity

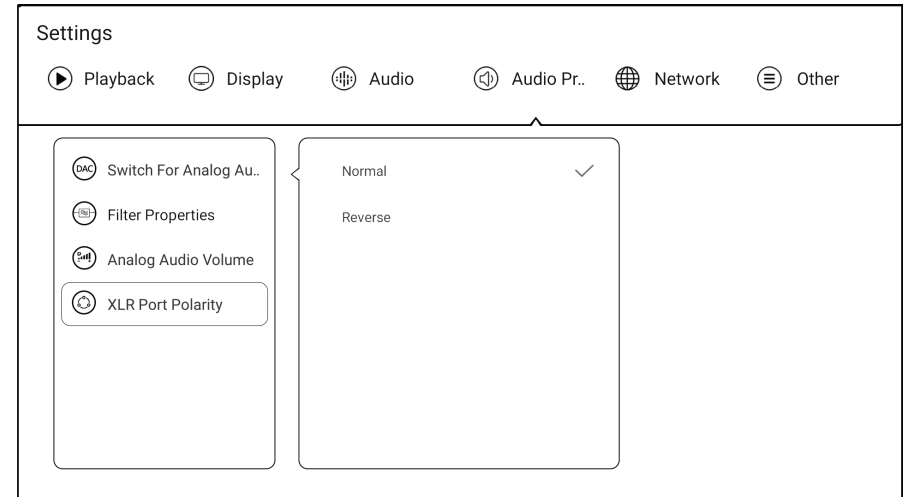

3) Analog Audio Volume

This Setting is only for DAC decoder, audio value is DAC Decoder Volume value.

INITIALIZATION

Before actually using this device, this software will provide you for first initialization. Please set your device according to the initialization process to obtain the optimum watching experience.

1. Language of the system

Select the language of the system as you need.

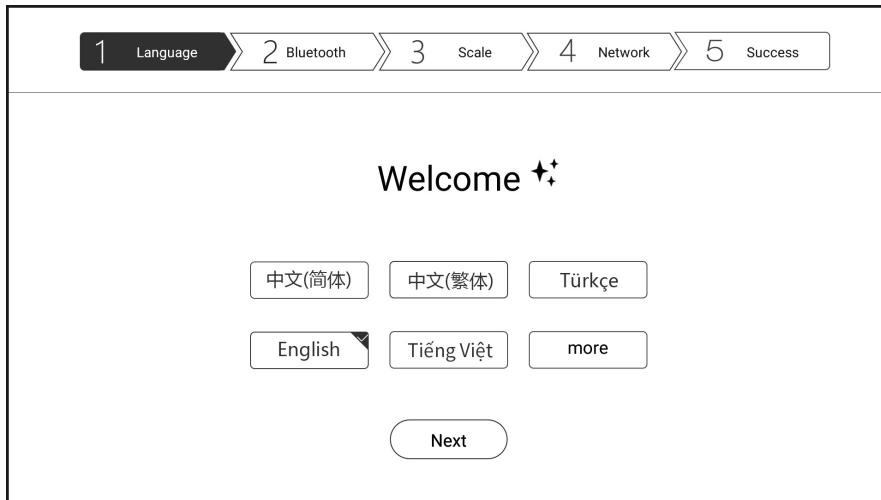

2. Bluetooth Match-Up

Let remote controller be aligned with Player and press Page-Down KEY and Menu KEY at the same time for least 5 second until indicator light blinking which matching succeed.

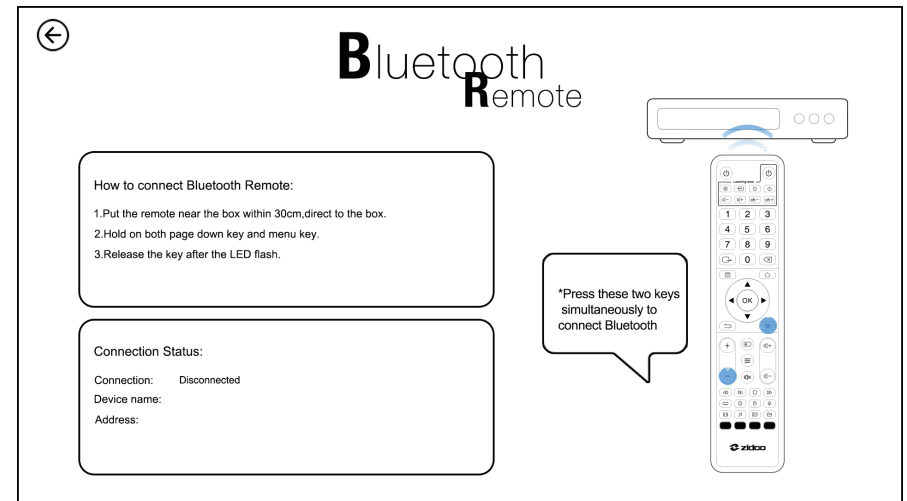
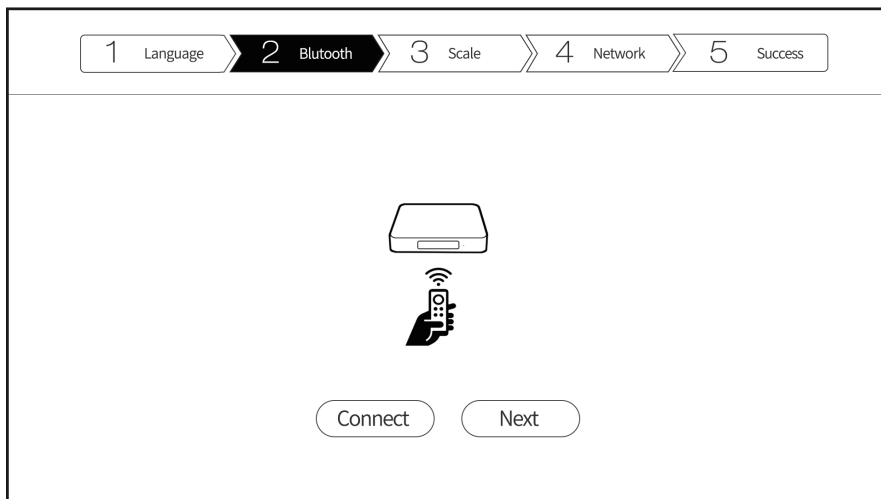

3. Screen scaling

Adjust the screen display range using LEFT or RIGHT button of the remote control or the mouse wheel so that the image can be displayed on the screen of the TV.

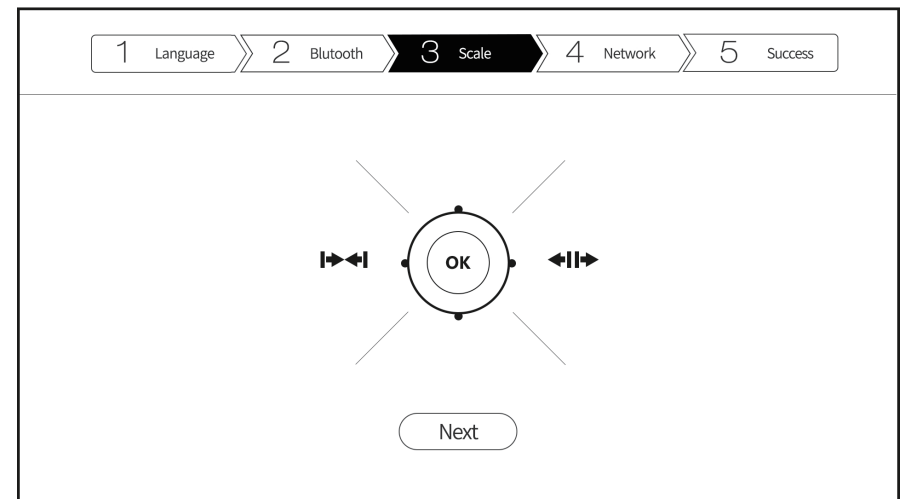

4. Network settings

Adjust the screen display range using LEFT or RIGHT button of the remote control or the mouse wheel so that the image can be displayed on the screen of the TV.

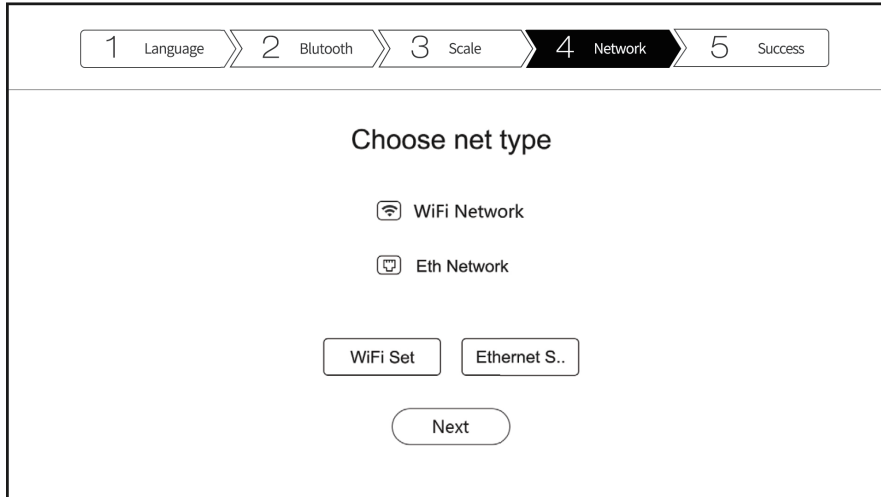

WIFI: Select SSID and enter password, connect to WIFI and finish setting;

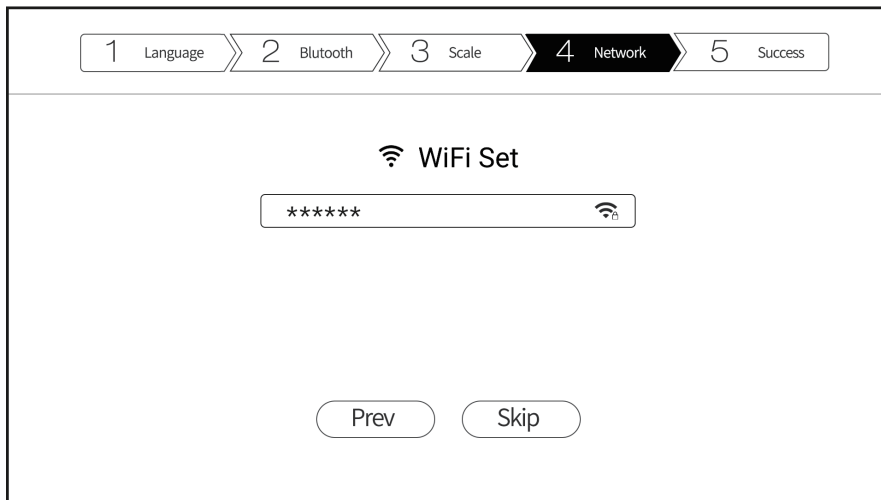

SYSTEM UPDATE BY OTA

Zidoo will update the firmware aperiodicity.

Find the system update icon in APP center and open it; support online network update and local update; after ticking "automatically detect the latest version", will receive the prompt for the latest firmware update automatically.

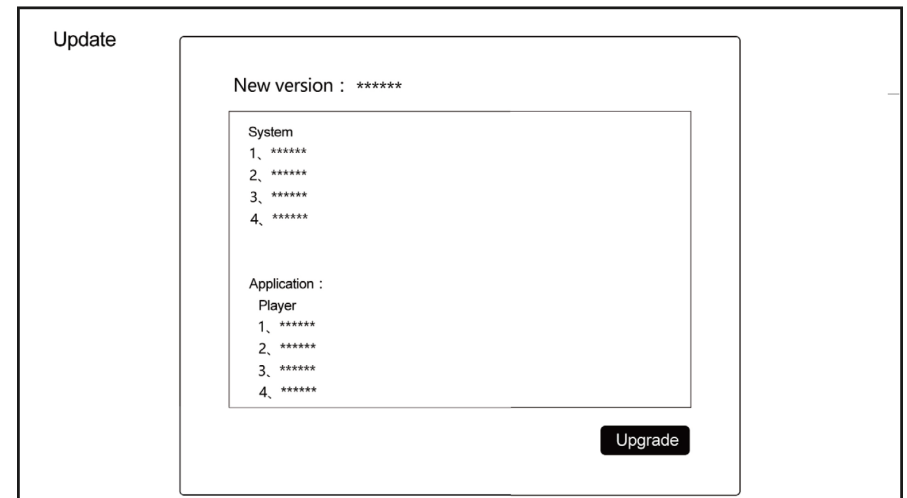
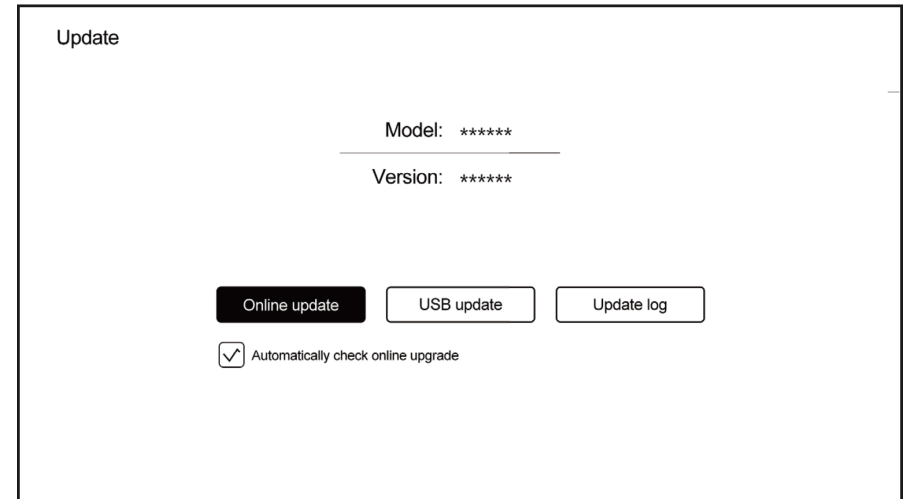

2. Local update

Users can download the update file on the forum or official website and update firmware by local update.

Copy the downloaded update file to USB disk. Click "local update" to select the update file.

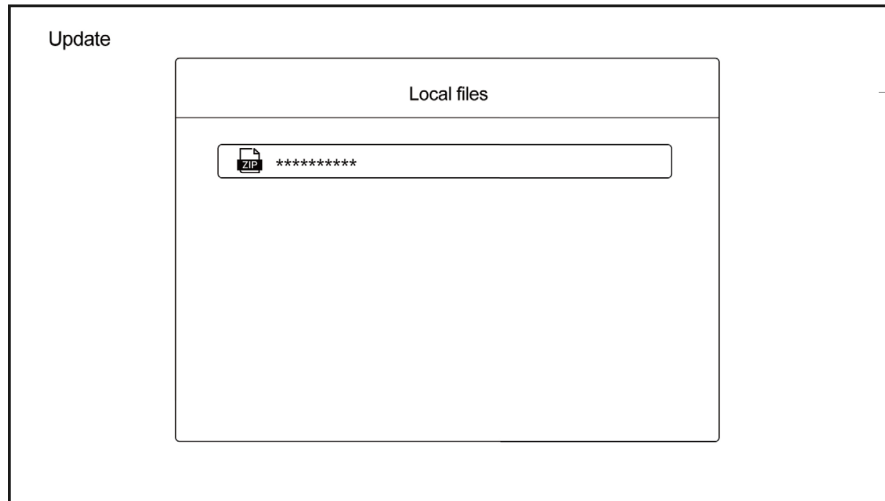

Download the update file by online update or local update. Click "update" to update.

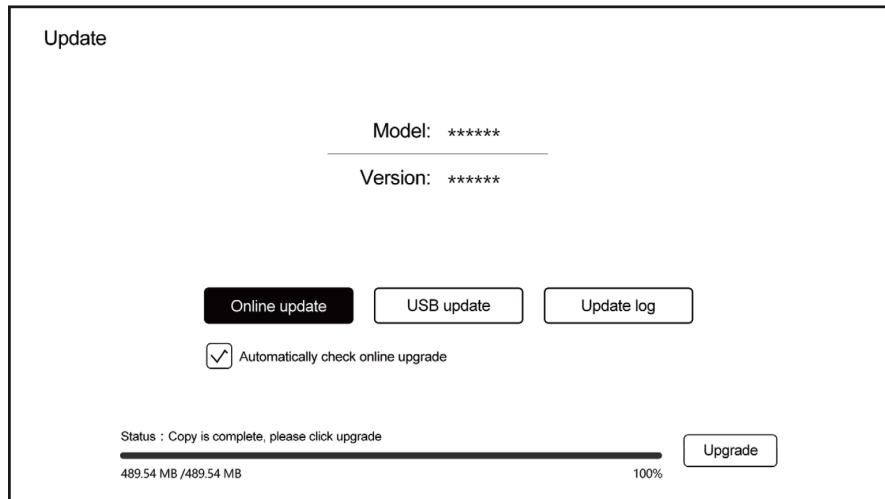

The system will automatically check the update file whether is complete or not.

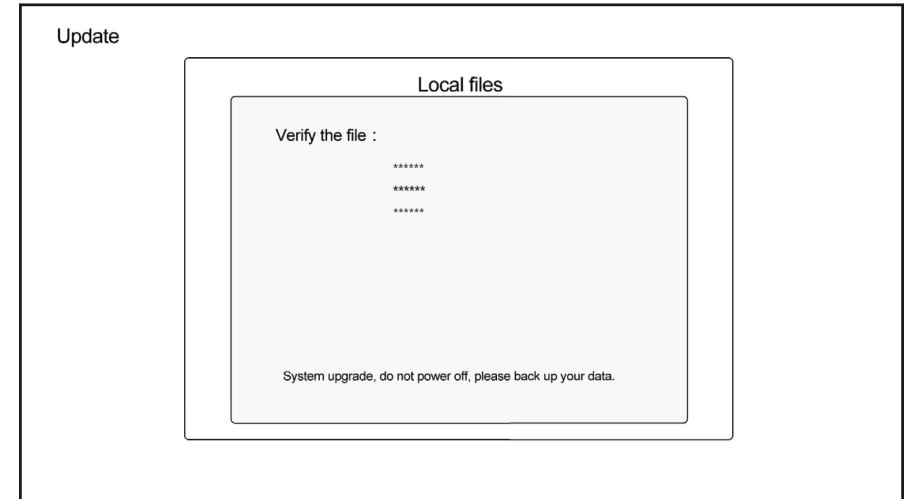

Note: Download the update file by online update or local update. Click "update" to update.

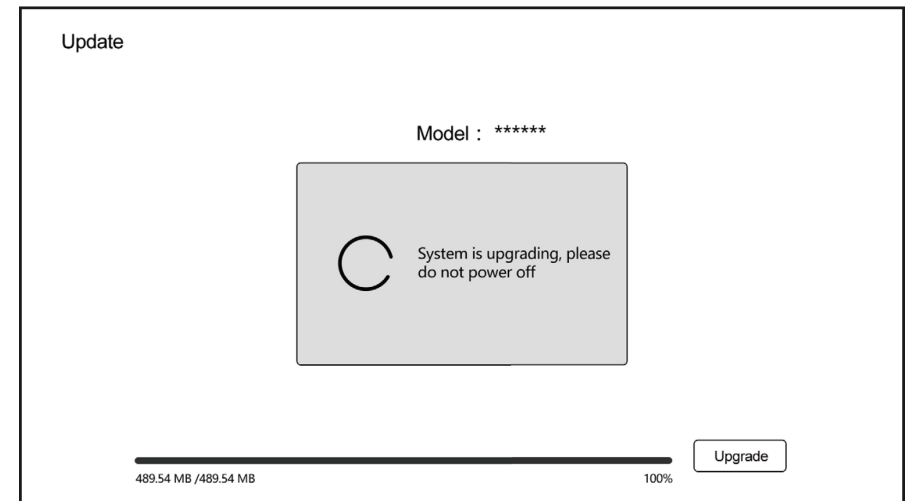

Once the update is completed, the system will automatically be restarted.



Special note:

To guarantee user experience, Zidoo will update the firmware periodically. Therefore, this manual may not be totally in line with the product.

Warning notice:

1.The equipment shall not be subjected to water splashing or water drop, and shall not be placed on the device such as a vase, which is full of liquid.

2.The disconnecting device of this product is the power plug. The socket provided to this product should be installed near the product, and should be easy to operate and cannot be blocked by other objects.

3.This product is classified as I equipment, and it must have grounding measures inside the time box.