

Thank you for using products of Zidoo. You can add our WeChat account or Weibo account to communicate and share with us.

 Facebook @ zidootv

 Twitter @ zidootv

---



 WeiChat Official Account @ **zidoo**



 Weibo Account @ **zidoo**

If you need more help, please visit user forum of the official website of Zidoo for consultancy.



Official website: [www.zidoo.tv](http://www.zidoo.tv)

# Content

## 01 Introduction to hardware of X10

Device interfaces	P2
Installation of hard disk	P4
Remote control	P5
Connect the device	P6
Performance parameters	P8

## 02 Introduction to hardware of X9S

Device interface	P9
Remote control	P10
Performance parameters	P11

## 03 Initialization

P12

## 04 System update by OTA

P14

# Introduction to hardware of X10

## Device interface

Zidoo X10 is equipped with audio input & output ports and data transmission port. Please refer to the descriptions in this manual.

### 1 Front

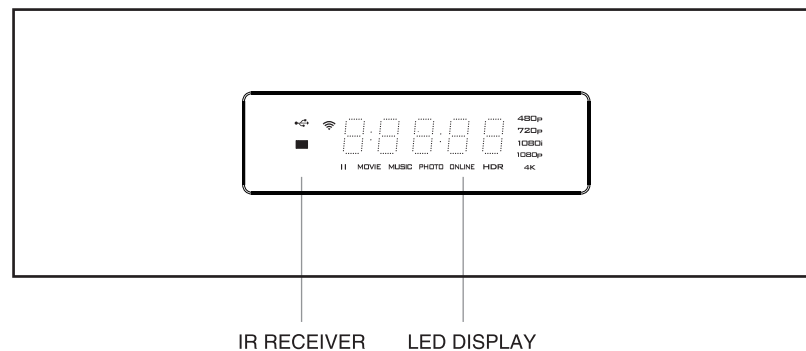

### 2. Right

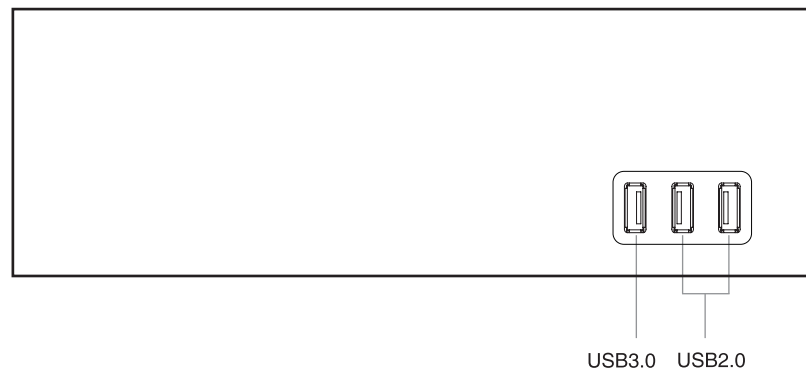

### 3. Left

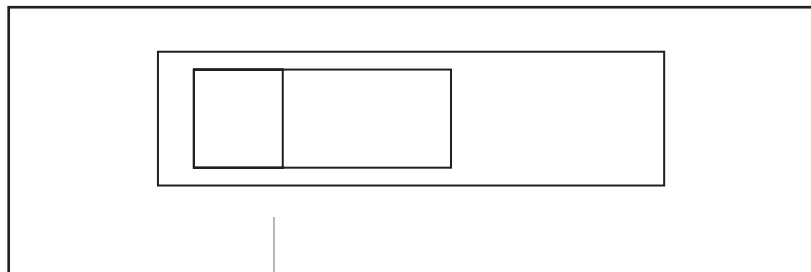

HARD DISK SUPPORT

### 4. Back

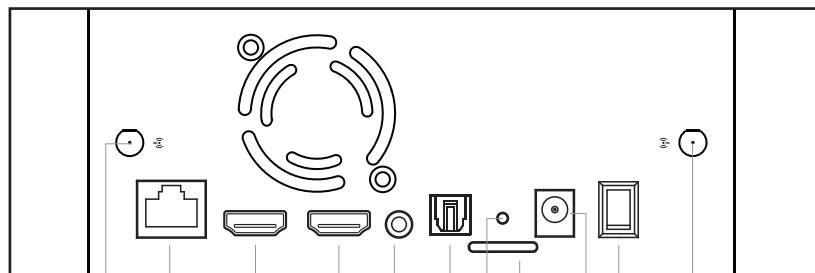

ANTENNA PORT    WIRED LAN PORT    HDMI OUT    HDMI IN    AV    OPTICAL FIBER    TF CARD SLOT    RESTORE    POWER SUPPLY    SWITCH    ANTENNA PORT

Instruction to installation of the antenna: please insert the two antennas in the parcel into the antenna ports in the above diagram.

Note:

- \*Please load/change the hard disk after turning off the power. If it is a brand-new hard disk,
- \*Please load it after formatting it.
- \*Please prevent the orifice of the cooling fan from being blocked.
- \*Do not touch any liquid in case the liquid runs into the inner part of the device and damages it.
- \*Any maintenance personnel who are not appointed are not allowed to open the case.

## Load the hard disk

X10 is equipped with hard disk storage of 3.5 inches and SATA high speed transmission port. The hard disk can be loaded by pushing it in, with no help of other tool. (The hard disk supports 10 TB at the maximum)

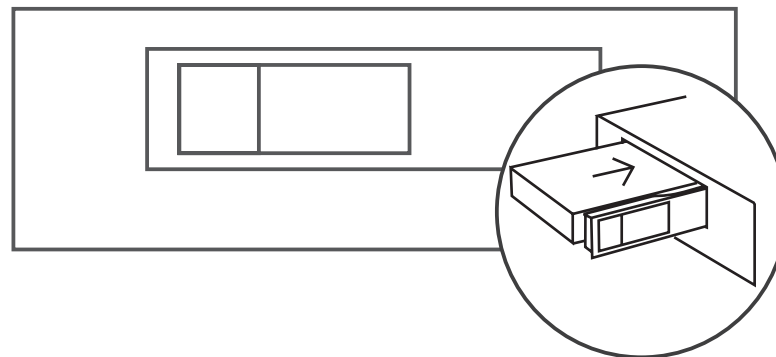

Note: Do not load or change the hard disk while the power is on in case that the device or the data of hard disk is damaged. If it is a brand-new hard disk, please format it before loading it to the device. This device support following formats of hard disk: EXT3, EXT4, NTFS, FAT32, EXFAT.

# Remote control

## 1. Description of functions of buttons.

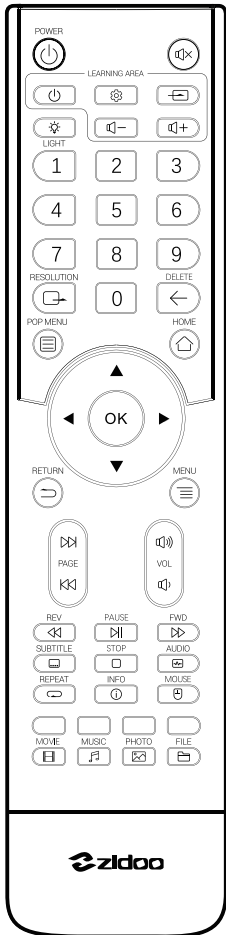

Functions	Buttons
Turn on/off	
TV Learning Area	
VOL+/VOL-/Mute	
Playback	
Media info	
Pop Menu	
Page up/down	
Mouse	
Home	
Return	
Menu	
Resolution	
Light	
Delete	
Numbers	1/2/3/4/5/6/7/8/9/0
Multi-function	
Shortcut	

## 2. Introduction to Learning button

Learning function: This remote control can copy functions of buttons of other remote control so that it can control two devices.

### Operation descriptions of Learning button:

- 1) Point the top of this remote control to that of the remote control to be copied. Align the infrared transmitting tubes.
- 2) Press in the study area of this remote control until its white backlight is lighted.
- 3) Press any button in the study area of this remote control, its white backlight flashes once.
- 4) Press the function button of the remote control to be copied. After this remote control receives the signal, the white backlight will quickly flash twice.
- 5) If there are many buttons functions need to be learned, please repeat step 3 and 4.
- 6) After completing learning, press any button outside the learning area of this remote control to exit learning mode. Then the white backlight of this remote control will be off automatically and completed learning.

## Connect the device (applicable to X10/X9S/X8)

### 1. HDMI connects to the TV.

- 1) Cut off the power of the device. Please make sure the power of both the TV and STB are off.



- 2) While the power of TV is off, insert one end of HDMI cable into HDMI OUT and insert the other end into HDMI IN port.

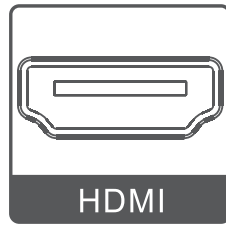

3) Connect with the power. This device is equipped with suitable DC power adapter. Please connect the head of DC power adapter to the DC power input port of this device, then insert the plug of DC power line into the alternating current socket of 110V – 240V.

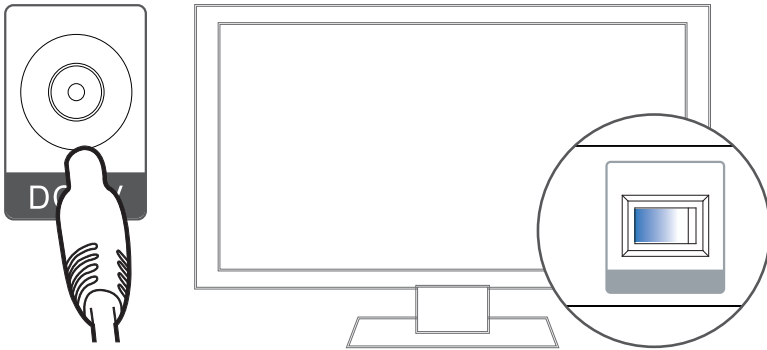

4) Corresponding video source is selected by TV.

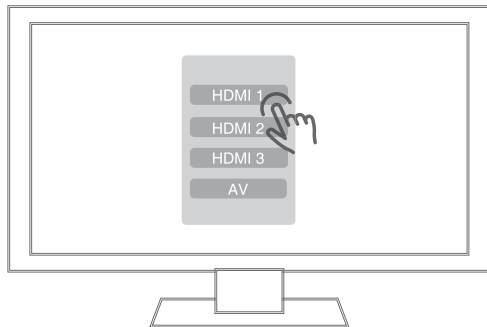

## 2. Connect AV cable with the TV.

The connection method is same as that of HDMI cable.

## X10 Specification

<b>Material</b>	Space Aluminium
<b>Display</b>	VFD display
<b>Shell</b>	Aviation Aluminum alloy case in smoke-colored
<b>OS</b>	Android 6.0 + OpenWRT(NAS) dual system run simultaneously
<b>CPU</b>	Realtek RTD1295 ARM Cortex-A53 Quad-Core with coating-point unit and NEON SIMD engine embedded
<b>GPU</b>	ARM T820 MP3(3-core)
<b>Memory</b>	2GB DDR3
<b>Internal Storage</b>	16GB eMMC
<b>Wifi Connectivity</b>	IEEE 802.11a/b/g/n, 802.11AC,4.900 GHz ~ 5.845 GHz (5.0 GHz ISM Band) RTK8821 dual-band WIFI
<b>Ethernet</b>	1*RJ-45 Ethernet Jack (10/100/1000Mbps)
<b>Bluetooth</b>	BT4.0
<b>HDMI Out</b>	HDMI with HDCP 2.2 output. Support 4K@60fps Support HD Audio(7.1CH), support 23.976 and 29.94
<b>HDMI In</b>	HDMI with HDCP 2.2 input, support PIP. HDMI IN stream recode and stream output via UDP etc...
<b>Video decode</b>	HDR, 10-bit HEVC/H.265 up to 4K @ 60fps, VP9 up to 4K @ 60 fps, H.264 up to 4K @ 24 fps, automatic frame rate switching
<b>Audio decode</b>	Support HD audio(7.1ch) decode and passthrough Redesigned Native player,Blu-ray better compatibility, Powerful subtitles , Support MVC ISO,MVC MKV. Built in ZDMC
<b>USB</b>	1 * USB3.0 2 * USB2.0 *External power needed if USB connects to over 1TB mobile HDD
<b>Power</b>	DC 12V/3A
<b>other interface</b>	1 * TF card reader SD card interface . Support1GB/2GB/4GB/8GB/16GB/32GB 1 * IR receiver 1 * AV OUT Composite video and audio port (Cvbs output) 1 * OPTICAL (2CH, 5.1CH) 2 * External high-gain Antenna 1 * HDD BAY 1 * VFD display (with LED light)

# Introduction to X9S hardware

## Interface of X9S

Zidoo X9S is equipped with audio input & output ports and data transmission port. Please refer to the descriptions in this manual.

### 1. Front

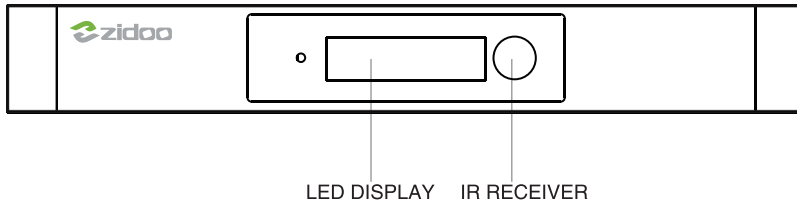

### 2. Right

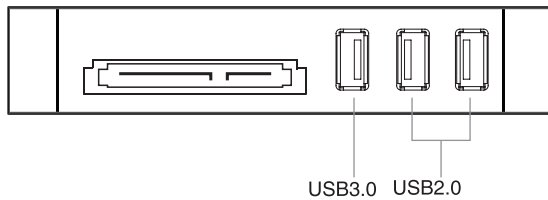

### 4. Back

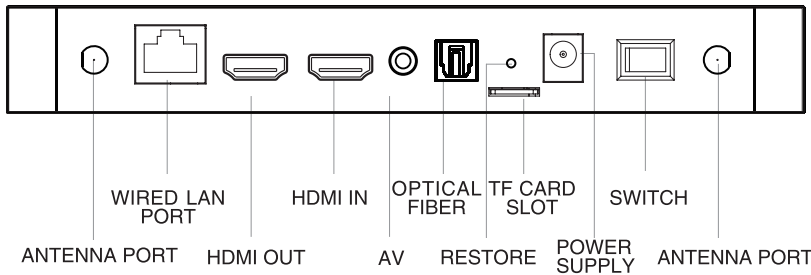

Instruction to installation of the antennas: please insert the two antennas in the parcel into the antenna ports in the above diagram.

## Remote control

### 1. Description of functions of buttons.

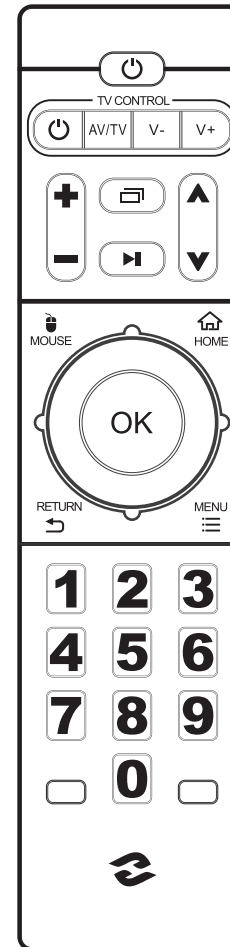

Functions	Buttons
Turn on/off	
TV Learning Area	
VOL+/VOL-	V+ / V-
Multitasking	
Pause/Play	
Page up/down	
Mouse	
Home	
Return	
Menu	
Numbers	1/2/3/4/5/6/7/8/9/0
Multi-function	

## X9S Specification

<b>Material</b>	Space Aluminium
<b>Display</b>	VFD display
<b>Shell</b>	Aviation Aluminum alloy case in smoke-colored
<b>OS</b>	Android 6.0 + OpenWRT(NAS) dual system run simultaneously
<b>CPU</b>	Realtek RTD1295 ARM Cortex-A53 Quad-Core with coating-point unit and NEON SIMD engine embedded
<b>GPU</b>	ARM T820 MP3(3-core)
<b>Memory</b>	2GB DDR3
<b>Internal Storage</b>	16GB eMMC
<b>Wifi Connectivity</b>	IEEE 802.11a/b/g/n, 802.11AC,4.900 GHz ~ 5.845 GHz (5.0 GHz ISM Band) RTK8821 dual-band WIFI
<b>Ethernet</b>	1*RJ-45 Ethernet Jack (10/100/1000Mbps)
<b>Bluetooth</b>	BT4.0
<b>HDMI Out</b>	HDMI with HDCP 2.2 output, Support 4K@60fps Support HD Audio(7.1CH), support 23.976 and 29.94
<b>HDMI In</b>	HDMI with HDCP 2.2 input, support PIP, HDMI IN stream recode and stream output via UDP etc...
<b>Video decode</b>	HDR, 10-bit HEVC/H.265 up to 4K @ 60fps, VP9 up to 4K @ 60 fps, H.264 up to 4K @ 24 fps, automatic frame rate switching
<b>Audio decode</b>	Support HD audio(7.1ch) decode and passthrough Redesigned Native player,Blu-ray better compatibility, Powerful subtitles , Support MVC ISO,MVC MKV.Built in ZDMC
<b>USB</b>	1 * USB3.0、 2 * USB2.0 *External power needed if USB connects to over 1TB mobile HDD
<b>Power</b>	DC 12V/3A
<b>other interface</b>	1 * TF card reader SD card interface . Support 1GB/2GB/4GB/8GB/16GB/32GB 1 * IR receiver 1 * AV OUT Composite video and audio port (Cvbs output) 1 * OPTICAL (2CH, 5.1CH) 1 * SATA3.0 ( To connect Serial ATA ) 1 * VFD display ( with LED light)

## Initialization

Before actually using this device, this software will provide you for first initialization. Please set your device according to the initialization process to obtain the optimum watching experience.

### 1. Language of the system

Select the language of the system as you need.

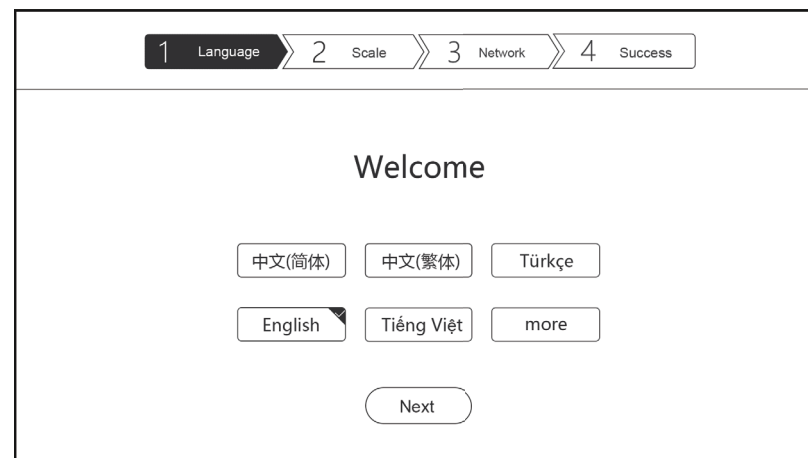

### 2. Screen scaling

Adjust the screen display range using LEFT or RIGHT button of the remote control or the mouse wheel so that the image can be displayed on the screen of the TV.

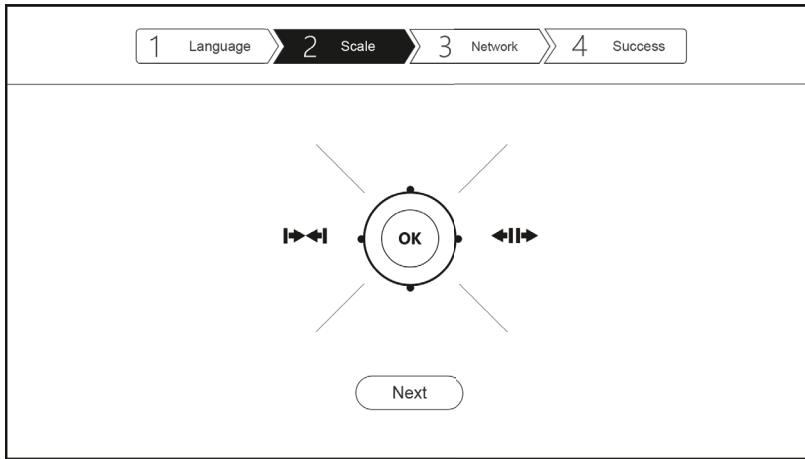

### 3. Network settings

Set the configuration of the network so that the device can quickly connect with the network. The network includes wifi network and Ethernet network. Select either of them and successfully connect with it.

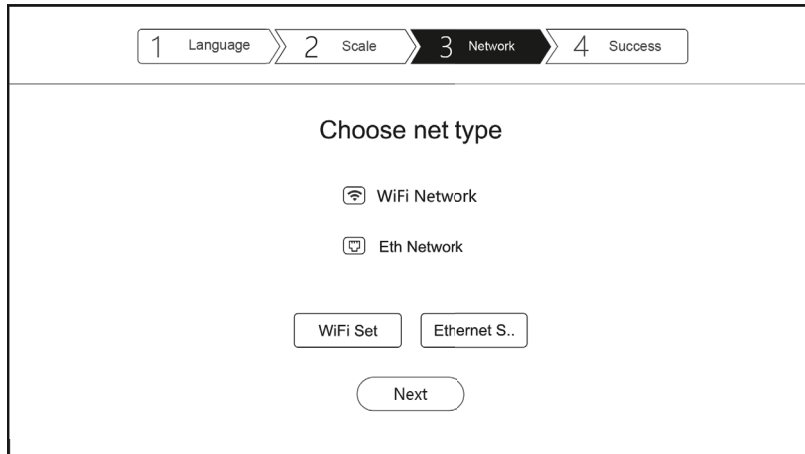

WiFi: Select SSID and enter password, connect to WiFi and finish setting;

Ethernet Network: no other operation needed but only need to insert cable and auto connect to internet. After finished the internet setting, please click Next to further step and get to know the function of the Home Page and finish initialization.

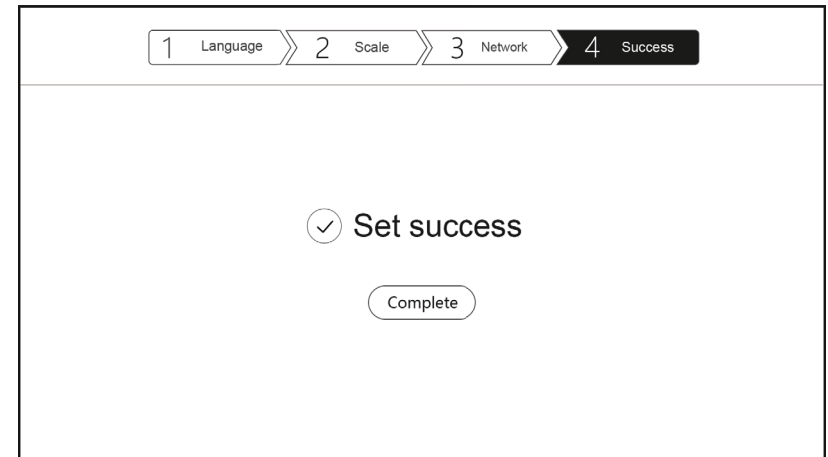

## System update by OTA

Zidoo will update the firmware irregularly.

Find the system update icon in APP center and open it; support online network update and local update; after ticking “automatically detect the latest version”, will receive the prompt for the latest firmware update automatically



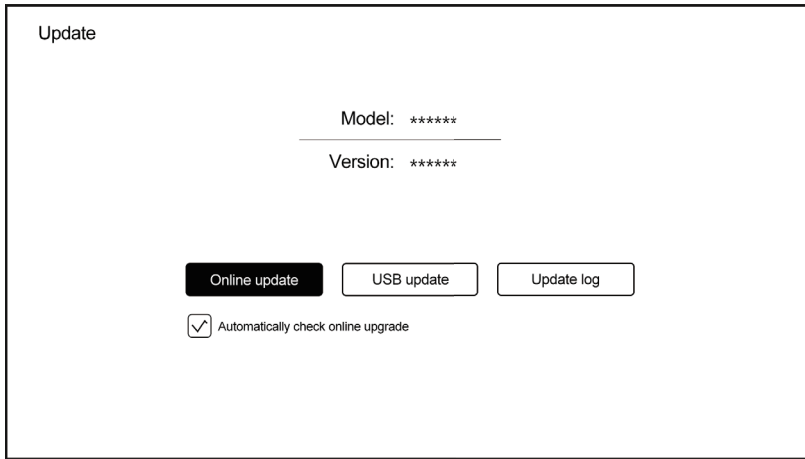

## 1. Online update

Click “online update” to obtain information of online update.

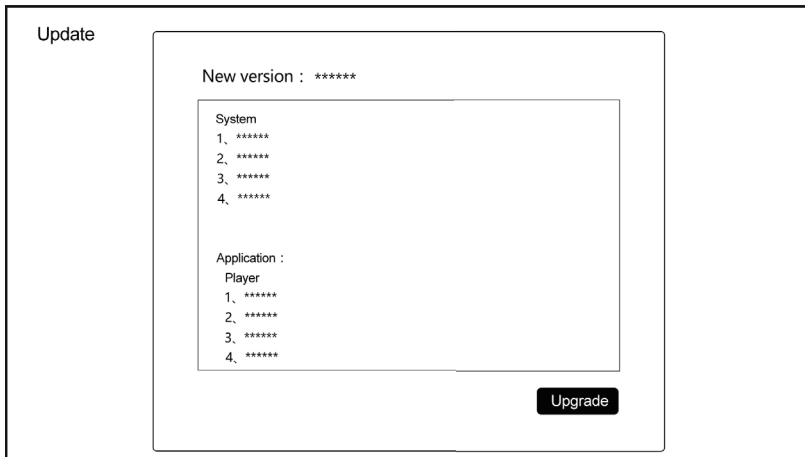

## 2. Local update

Users can download the update file on the forum or official website and update firmware by local update.

Copy the downloaded update file to USB disk. Click “local update” to select the update file.

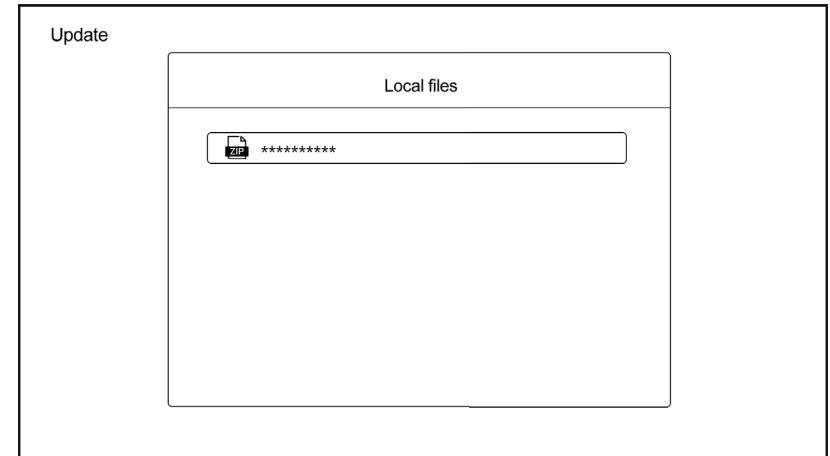

Download the update file by online update or local update. Click “update” to update.

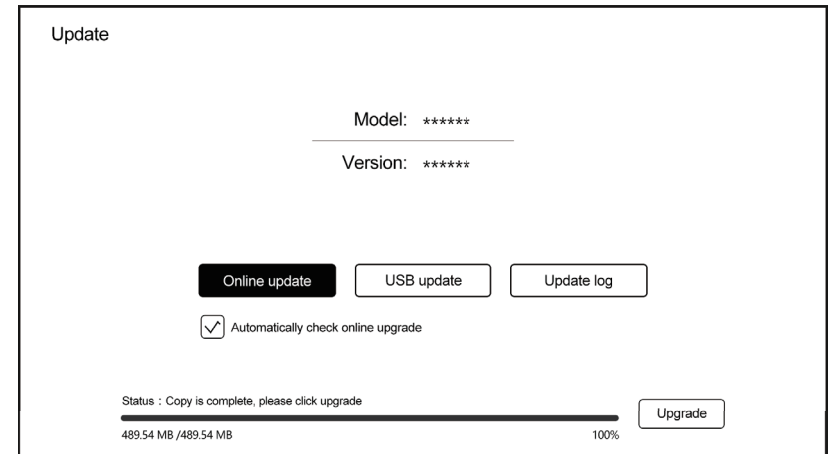

The system will automatically check the update file whether is complete or not

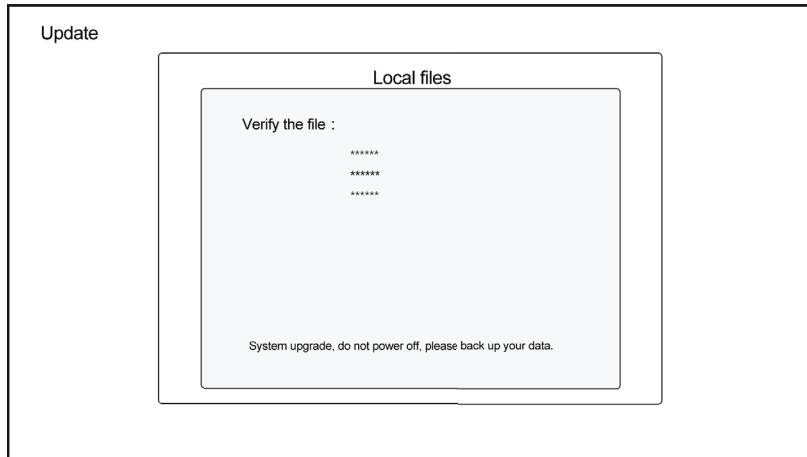

Note : Download the update file by online update or local update. Click "update" to update.

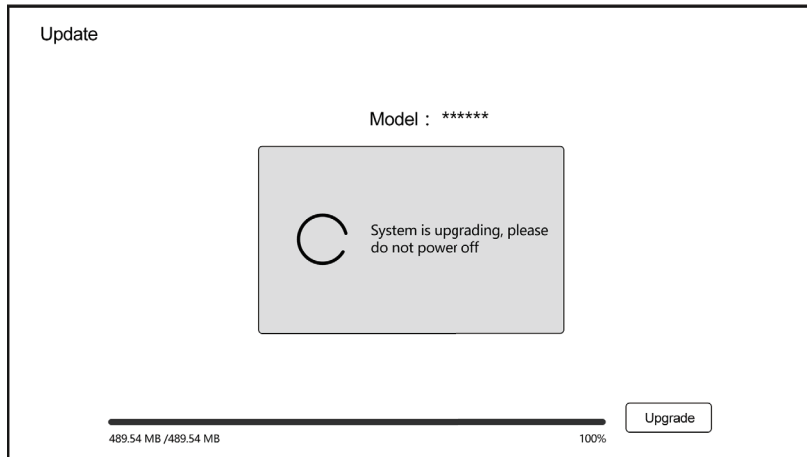

Once the update is completed, the system will automatically be restarted.

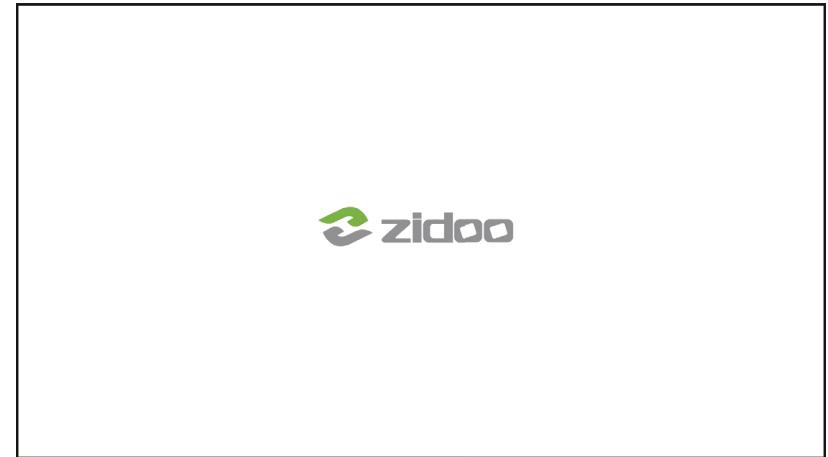

Special note: To guarantee user experience, Zidoo will update the firmware irregularly. Therefore, this manual may not be totally in line with the product.