

感谢您使用芝杜 zidoo 旗下产品，您可以关注我们的社交平台账号，和我们一起交流与分享。

Thank you for choosing products of Zidoo. Friend us on WeChat or Weibo to communicate and share with us.



微信公众号 @ zidoo
WeChat Official Account



微博账号 @ 芝杜官方
Weibo Account



Facebook @ zidootv



Twitter @ zidootv

如需更多帮助，请访问芝杜 zidoo 官网的用户论坛进行咨询

If you need more assists, please visit user forum of the official website of Zidoo for consultation.



官网网址 /Official website: www.zidoo.tv

目录 / Content

01	UHD3000 硬件介绍	
	设备接口	P1
	性能参数	P2
	装载硬盘	P3
	设备连接	P4
02	开机初始化向导	P7
03	DAC 模拟音频	P12
04	OTA 系统升级	P14

01	Introduction to hardware of UHD3000	
	Device Interface	P18
	Performance Parameters	P19
	Installation of hard disk	P20
	Device Connection	P21
02	Boot initialization wizard	P24
03	DAC analog audio	P29
04	System update by OTA	P31

UHD3000 硬件介绍

设备接口

Zidoo UHD3000 配备有丰富的音视频输入输出接口及数据传输接口，请参考本手册内容。

1. 正面

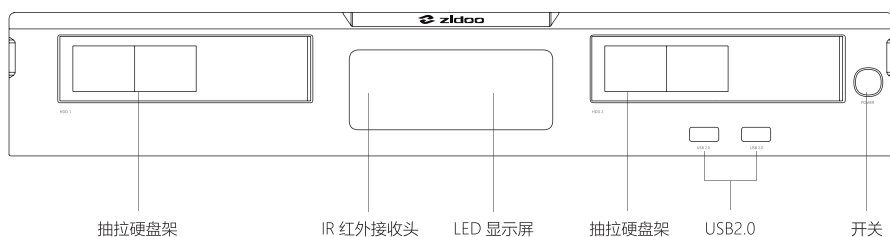

2. 背面

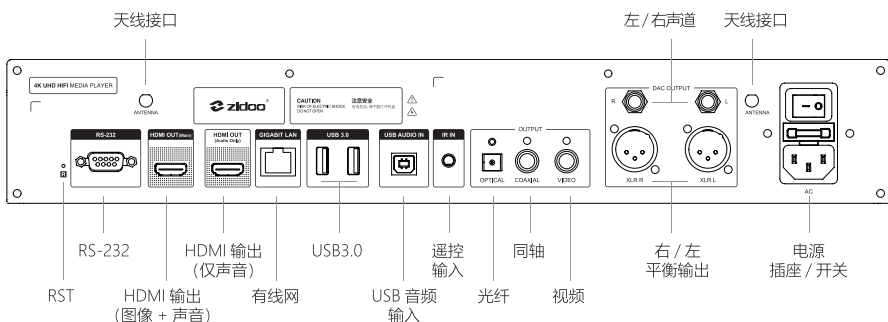

天线安装说明：请将附件中的两根天线安装至上图所示的天线接口。

注意：

- * 请在断电情况装载\更换硬盘，如是全新硬盘，请格式化后装载。
- * 请勿将任何物品遮挡散热风扇孔。
- * 请勿接触液体，以免流入设备内部造成损坏。
- * 非指定维修人员，请勿拆开机壳。

性能参数

机壳材质	航空铝合金外壳
操作系统	Android 9.0
CPU 型号	Realtek RTD1619DR ARM Cortex-A55(六核)
GPU	ARM Mali-G51 MP3
内部存储	4GB DDR4 内存 +32GB eMMC 闪存
蓝牙	BT 4.2
WiFi 网络	2.4G+5G 双频 WiFi, 802.11 a/b/g/n/AC; 2T2R MIMO 867Mbps
有线网络	1*RJ-45(10/100/1000Mbps)
HDMI 输出	2.0a (4K@60fps/12Bit/HDR/BT2020/YCbCr 4:4:4 输出) +1.4 (Audio Only 源码透传) 音画分离输出
视频解码	4K@60p HEVC/H.265 12Bit HDR10, HDR10+, 杜比视界
USB 音频输入	支持 Windows (7/10)、Mac、Android; 输入解码格式最高支持两声道 DSD512、PCM 768KHz@32bit PCM
其他音频输出	1* 光纤输出、1* 同轴输出、 1*RCA 左 / 右声道、XLR 左 / 右声道平衡
音频解码	Hi-Fi 解码方案 (XMOS 音频界面 +ESS 9068 DAC) 支持 DSD、MQA 解码
PCM 解码格式	采样频率: 44.1 kHz、48 kHz、88.2 kHz、96 kHz、176.4 kHz、192 kHz、352.8 kHz、384 kHz、768 KHz 位宽: 16 Bit、24 Bit、32 Bit
DSD 解码格式	采样频率: 2.8224 MHz (DSD64)、5.6448 MHz (DSD128)、11.2896 MHz (DSD256)、22.5792 MHz (DSD512 Native 模式) 位宽: 1Bit
模拟音频特性	频率范围: 20Hz-20KHz +/-0.35dB; 信噪比 (SNR):>128dBra; 总谐波失真 + 噪音 (THD+N):< 0.00026% ; 输出电平:(XLR) 4.0±0.4Vrms. (RCA) 2.2±0.2Vrms. ; 动态范围 (DNR):>125dB; 通道分离度 (Crosstalk):>135dBra
电源	AC 110~120/220~240V 50/60Hz
SATA	内置独立 2*SATA3.0 3.5 寸硬盘仓 (不含硬盘)
其他接口	1*IR 红外输入, 1*RCA 复合视频, 1*RS232, 2*USB3.0、2*USB2.0
随机附件	1* 遥控器, 1* 电源线, 2* 天线, 1* 用户手册

装载硬盘

UHD3000 搭载 3.5 寸硬盘仓，内置 SATA 高速传输接口，无需借助任何工具，将硬盘 SATA 接口朝里轻松推入即可装载（硬盘最大支持 14TB）。

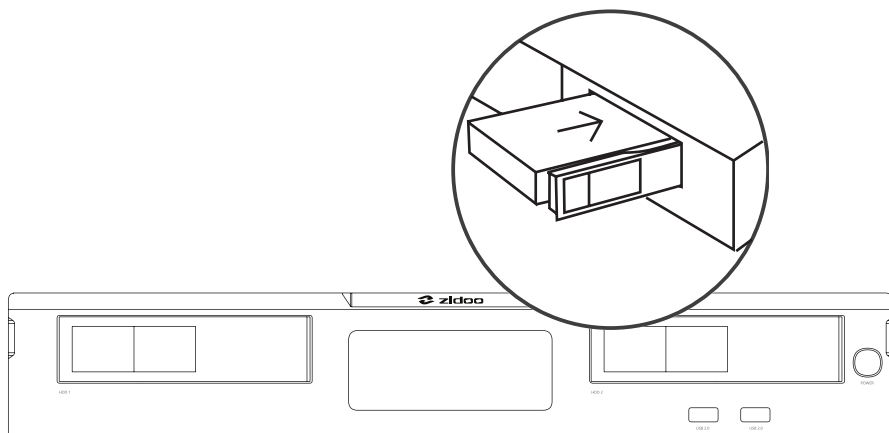

注意：请勿在设备通电的状态下装载或更换硬盘，以免造成设备或硬盘数据损坏，如果是全新硬盘，请先格式化硬盘再装载至设备，本机支持硬盘格式为：EXT3,EXT4,NTFS,FAT32,EXFAT。

设备连接

1.HDMI 连接电视

UHD3000 拥有两种 HDMI 连接方式，一种是单口输出，另一种是双口输出，请参考以下步骤进行连接。

① 将设备断电，请务必保证电视机与机顶盒都在断电的状态下操作。

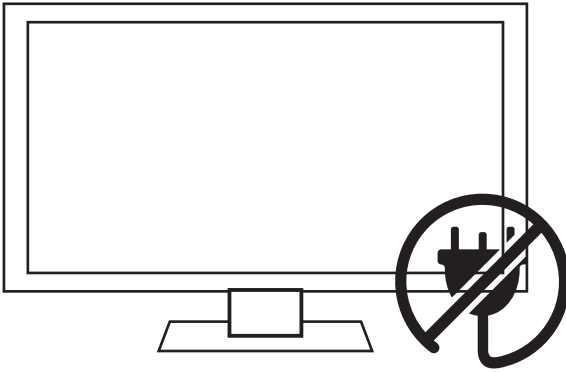

② 单口输出：在电视机与播放机都断电的情况下，将 HDMI 线一头插入设备的 HDMI OUT MAIN 接口、另一头插入电视 HDMI IN 接口；

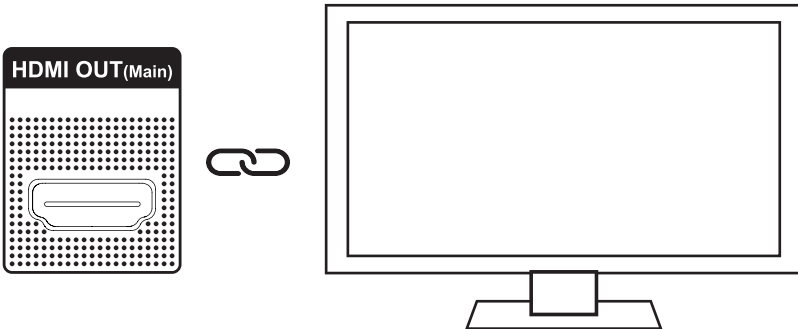

4K Hi-Fi 媒体播放机

③ 双口输出（显示画面和声音分开输出）：在电视机与播放机都断电的情况下，将 HDMI 线一头插入设备的 HDMI OUT AUDIO ONLY 接口、另一头接入功放；再用另一根 HDMI 线一头插入设备的 HDMI OUT MAIN 接口，另一头接入电视 HDMI IN 接口，即可实现音画分离输出；（双口输出方式适合功放设备不支持 4K 或 3D 功能，显示设备支持 4K 或 3D 功能时使用。）

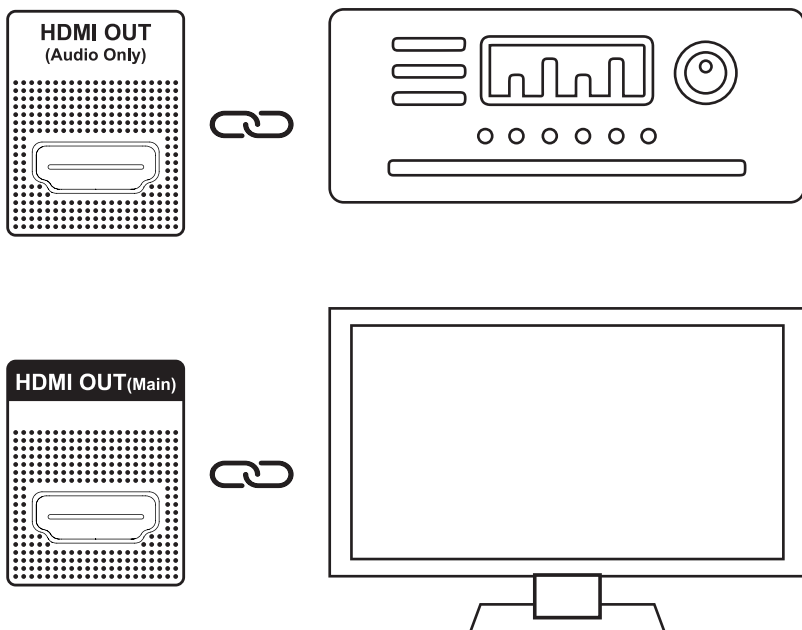

④ 电源连接：本设备内置电源，请将随机附赠的电源线插入本机的 AC 电源插座，将电源线的另一头接入交流 110~120/220~240V 的电源插座后，打开 AC 电源插座上的电源开关；

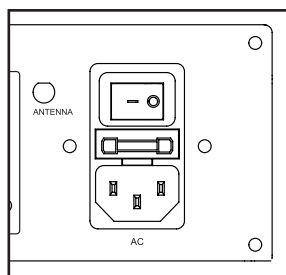

⑤ 按下机器前面板右侧的开机按钮或按下遥控器电源键进行开机，并打开电视机；

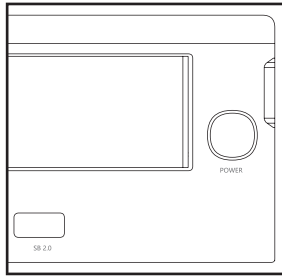

⑥ 电视选择对应的视频源。

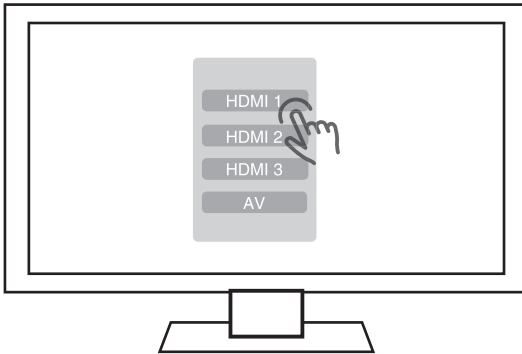

2. 其它连接方式

其它连接方式与 HDMI 线的连接步骤相同，请先将线路连接好再通电。

开机初始化向导

正式使用机器前，系统将会为您进行第一次初始化设置。请根据实际设备搭配和使用需求来设置您的设备，以获得最佳的观影体验。

1. 系统语言选择、屏幕缩放、时区设置

按照您的语言习惯选择系统语言。



按遥控器左右方向键调节合适的屏幕显示大小。

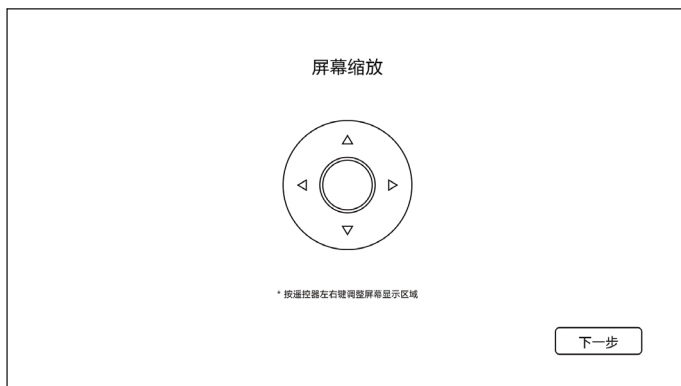

根据您所处地区选择对应系统显示的时区。

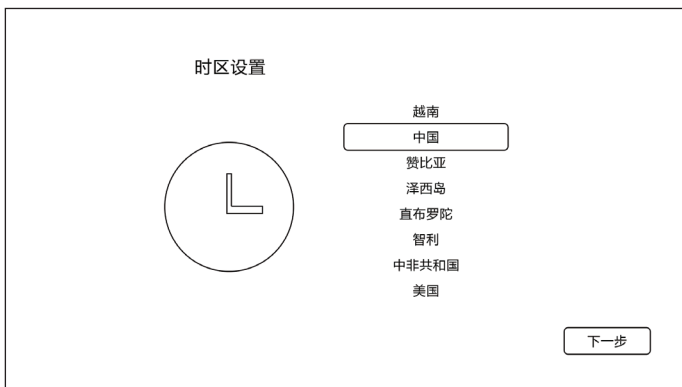

2. 蓝牙遥控配对

遥控器对准机器，距离 30 厘米以内，同时按住翻页下键与菜单键 5 秒至指示灯闪烁，进行配对，配对完成之后指示灯熄灭。

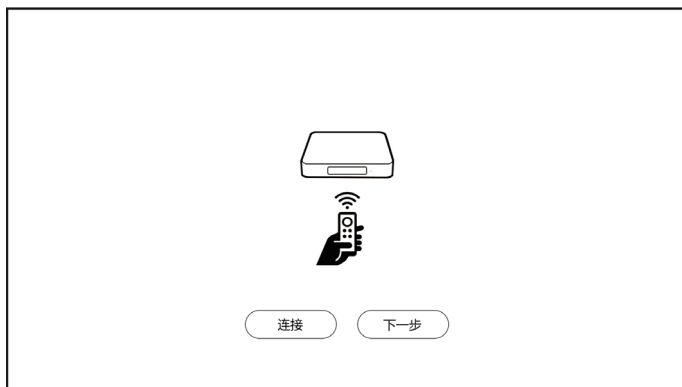

配对详情

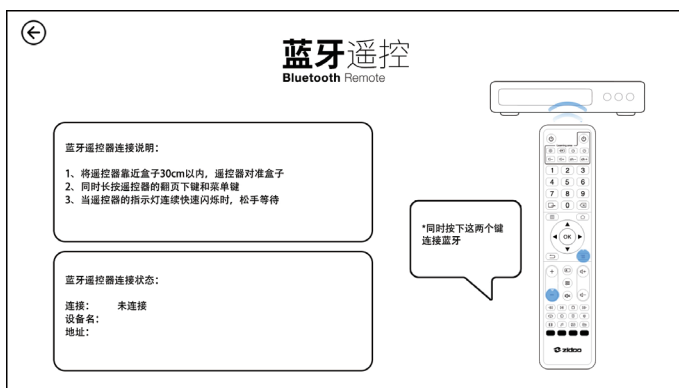

3. 网络设置

设置相关网络配置, 让机器快速连接网络。

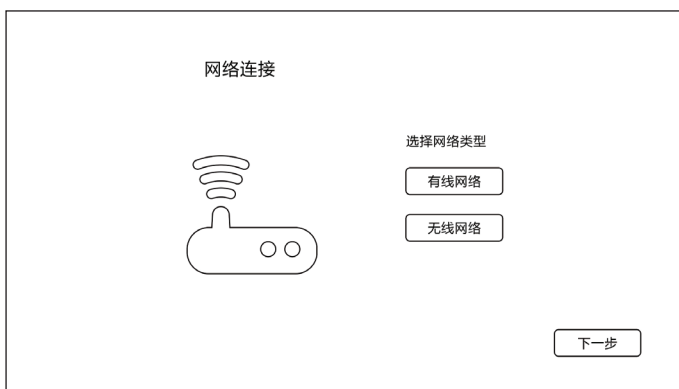

无线网络 (WIFI) : 选择网络 SSID, 输入密码, 连接 WiFi。

有线网络: 只需插入网线即可自动连接网络。

4. 选择输出模式

请根据需要选择相应的模式来完成设备输出参数的设置。

向导模式： 根据您的使用环境和设备连接情况选择对应的选项。

自动模式

请选择设备连接方式：

- 1.直接连接电视
- 2.HDMI连接1.4功放，功放再连接到电视
- 3.HDMI连接2.0功放，功放再连接到电视
- 4.HDMI连电视，光纤或同轴连接功放



音频直接解码输出

专家模式： 音视频输出为自定义选择模式，可根据设备连接和支持的规格选择相应的音视频输出，此模式建议专业人员操作。

专家模式

分辨率选择

HDR模式

视频帧率切换

音频输出

HDR模式

映射HDR10
所有内容都会映射成HDR10输出，最高支持HDR10+

最高SDR Rec.709
所有内容都会转换成SDR Rec.709输出

最高SDR Rec.2020
最高支持SDR Rec.2020输出，HDR内容将转换成SDR Rec.2020

杜比视界VSI0引擎
使用杜比视界VSI0引擎处理HDR内容以获得最好的画面质量，并根...

自动
根据播放内容与显示设备能力智能判断决定输出SDR,HDR或者杜比视界

5. 按键定义

根据您的使用习惯定义遥控器上的数字键，选时键，字幕键，音轨键，上下键，翻页键对应的功能。

按键定义

数字键	特定百分比原播放	>
选时键	关闭	>
字幕键	字幕列表	>
音轨键	音轨列表	>
上下键	切换章节	>
翻页键	切换章节	>

完成以上设置后，按照提示点下一步完成整个设备的初始化设置，即可享受芝杜产品给您带来的影音盛宴。

DAC 模拟音频

1. 音频源

如需通过模拟 XLR 平衡或 RCA 端口连接音箱系统输出音频，需要打开音频源开关。打开此开关声音将会通过 XMOS 输出（DSD 直通）到 DAC 解码，可获得原生最高 DSD 512 和 PCM 768 高采样 Hi-Fi 音质。打开此开关时，HDMI 和 SPDIF 将不输出声音。

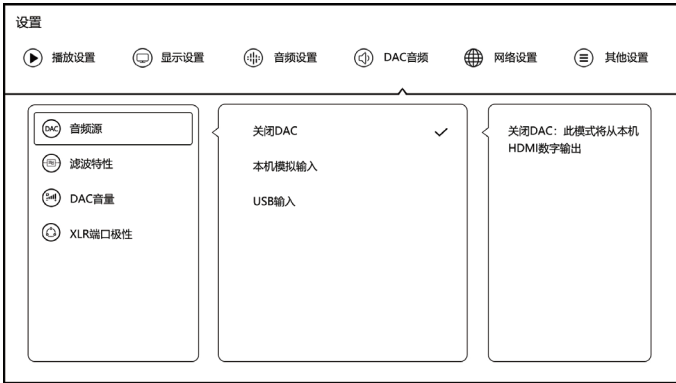

2. 滤波特性

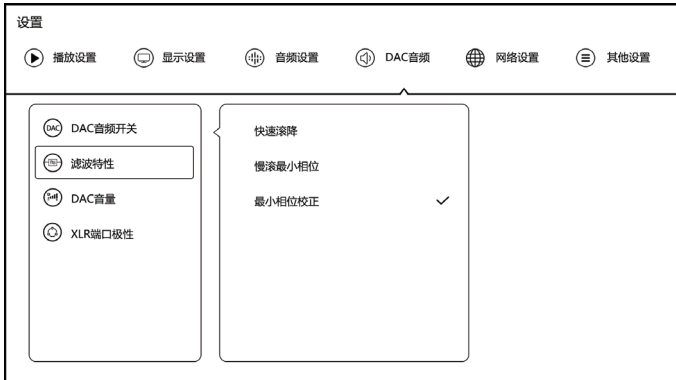

3. 模拟声音音量

此音量设置只针对 DAC 解码器，声音数值是 DAC 解码器的音量数值。

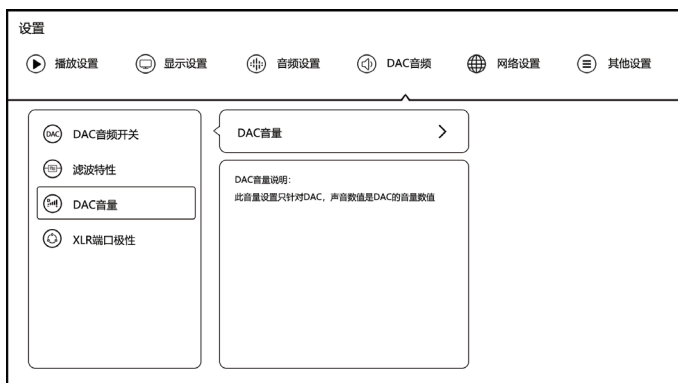

4. XLR 端口极性

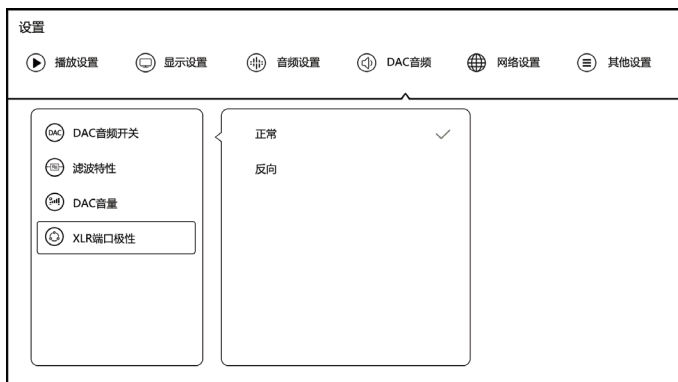

OTA 系统升级

芝杜 ZIDOO 会不定期更新固件。

在应用中心找到系统升级图标点击打开；支持在线网络升级与本地升级两种方式；勾选自动检测在线升级后，您将会收到最新的系统升级提示。



1. 在线升级

点击“在线升级”选项，获取在线升级信息后即可进行升级。

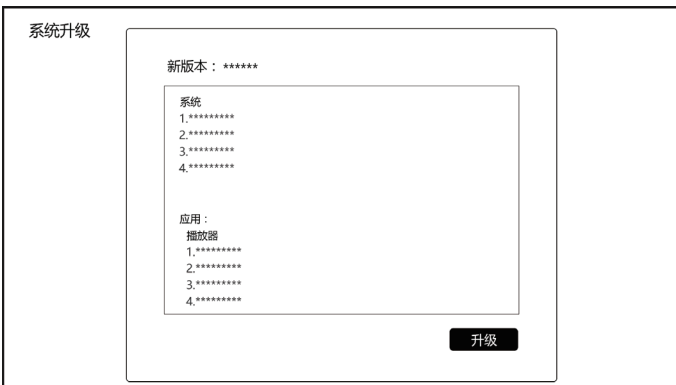

2. 本地升级

用户可通过在论坛或官网手动下载升级文件，通过本地升级的方式自行升级系统。

将下载好的升级文件拷贝到 U 盘，通过点击“本地升级”选项，选择升级文件。

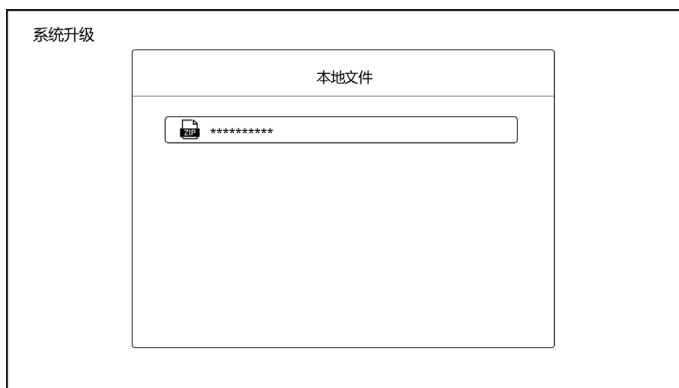

通过在线升级或本地升级下载完升级文件后，点击“升级”选项，开始升级。

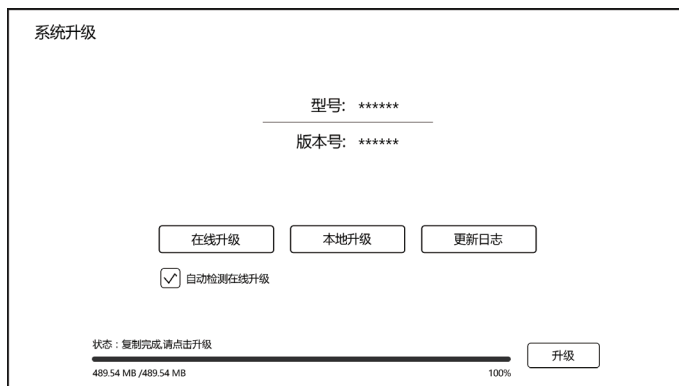

开始升级后，系统会自动检验升级文件是否完整。



注意：自动进入系统升级，该过程请不要断电。

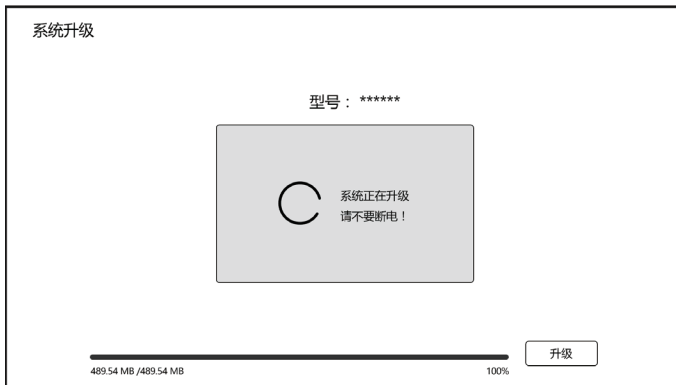

升级完成，自动重启系统。



特别说明：

为了保证用户体验，芝杜 ZIDOO 会不定期更新固件，因此，本说明书的操作说明，有可能会与产品实际使用情况稍有出入，请以实际情况为准。

安全警示：

1. 本设备不得遭受水溅或水滴，不得在设备上放置类似花瓶一类装满液体的物品。
2. 本产品断开装置为输入插座，配备给本产品使用的插座应当装在本产品附近，且应当便于操作，不能被其他物体阻挡。
3. 本产品为 I 类设备，使用时机箱内部必须要有接地措施。

INTRODUCTION TO HARDWARE OF UHD3000

Device interface

Zidoo UHD3000 is equipped with multiple audio input / output ports and data transmission ports. Please refer to the descriptions in this manual.

1.Front

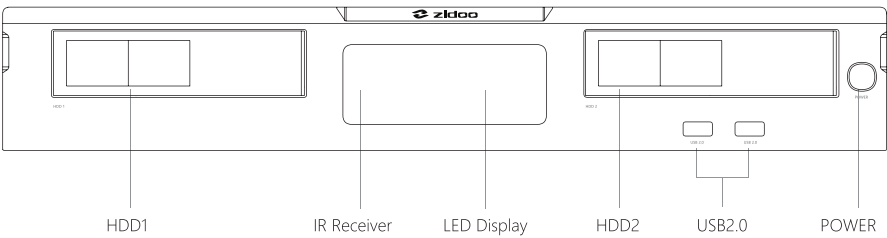

2.Back

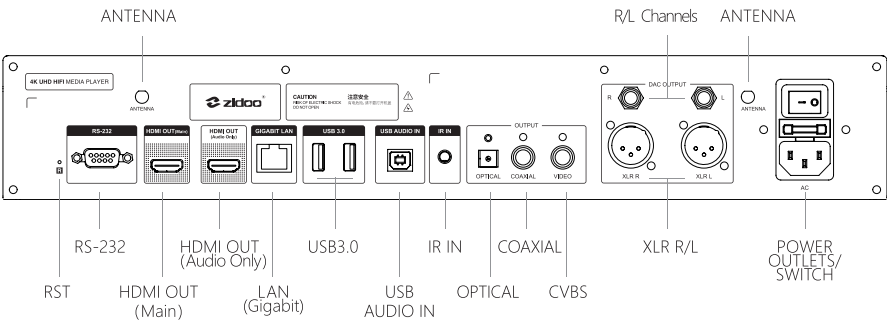

Antennas installation instruction: please install two antennas in the accessories box to the antenna interfaces shown in the diagram above.

Notices:

*Please load/change the hard disk after turning off the power. If it is a brand-new hard disk, please load it after formatting it.

*Please prevent the orifice of the cooling fan from being blocked.

*Do not touch any liquid in case the liquid runs into the inner part of the device and damages it.

*Any maintenance personnel who are not appointed are not allowed to open the case.

PERFORMANCE PARAMETERS

Chassis	Aviation aluminum alloy
OS	Android 9.0
CPU	Realtek RTD1619DR ARM Cortex-A55(hexa-core)
GPU	ARM Mali-G51 MP3
Storage	4GB DDR4+32GB eMMC
Bluetooth	BT4.2
WiFi	2.4G+5G dual band WiFi, 802.11 a/b/g/n/AC 2T2R MIMO 867Mbps
Ethernet	1*RJ-45(10/100/1000Mbps)
HDMI Output	2.0a (4K@60fps/12Bit/HDR/BT2020/YCbCr 4:4:4 output) +1.4 (Audio Only audio passthrough) separate audio and video output
Video Decoding	4K@60p,HEVC/H.265 12Bit,HDR10,HDR10+,Dolby Vision
USB Audio Input	Support Windos (7/10) 、 Mac、 Android; Input decoding format supports up to stereo DSD512、 PCM 768KHz@32bit PCM
Other Audio Ports	1*Optical,1*Coaxial,1*RCA L/R,XLR L/R balanced
Audio Decoding	Hi-Fi decoding solution (XMOS + ESS 9068 DAC) Support DSD, MQA decoding
PCM Decoding Formats	Sampling frequency:44.1 kHz,48 kHz,88.2 kHz,96 kHz,176.4 kHz,192 kHz,352.8 kHz,384 kHz,768 KHz Bit width:16 Bit,24 Bit,32 Bit
DSD Decoding Formats	Sampling frequency: 2.8224 MHz (DSD64),5.6448 MHz (DSD128),11.2896 MHz (DSD256),22.5792 MHz (DSD512 Native mode)Bit width:1Bit
Analog Audio Characteristics	1* Optical、 1* Coaxial、 1*RCA left/right channels、 XLR left/right channels balance
Analog Audio Characteristics	Frequency range:20Hz-20KHz +/-0.35dB; SNR:>128dBrA;THD+N:< 0.00026% ;Output level:(XLR) 4.0±0.4Vrms. (RCA) 2.0±0.2Vrms;DNR:>125dB; Crosstalk:>135dBrA
Power Supply	AC 110~120/220~240V 50/60Hz
SATA	2*SATA3.0 and 3.5" HDD bay (HDD is not included)
Other Ports	1*IR in,1*RCA composite video connector, 1*RS232,2*USB3.0,2*USB2.0
Accessories	1*remote control,1*power cable,2*antennas,1*user manual

LOADING HARD DISK

UHD3000 has two 3.5 inches HDD bays with built-in high-speed SATA jacks, Please slowly push 3.5 inches hard disk with SATA interface toward HDD bay without any tools (Hard Disk support 14TB Maximum)

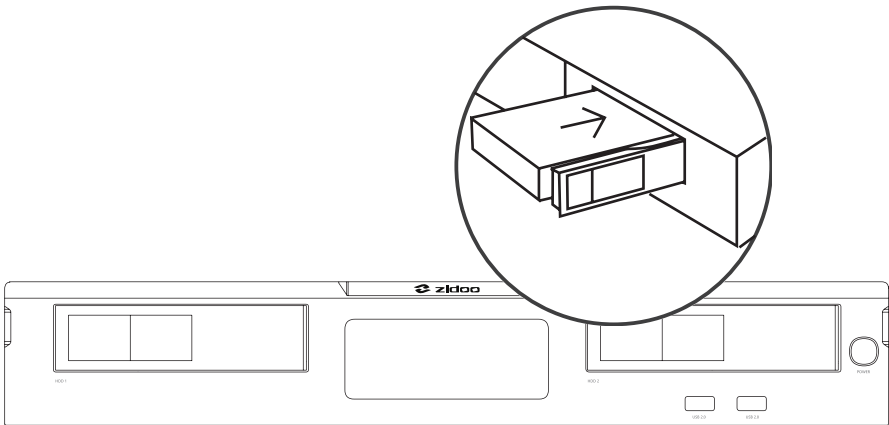

Notice:

Please do not load or change the hard disk when powering on and in order to avoid damage the disk and data. This device support hard disk formats:EXT3,EXT4,NTFS, FAT32,EXFAT.

Connection with Device

1.HDMI connects to the TV.

UHD3000 have two ways to connect HDMI. One is stand-up output mode and another one is Double output mode.

① Cut off the power of the device. Please make sure the power of both the TV and Media Player are off.

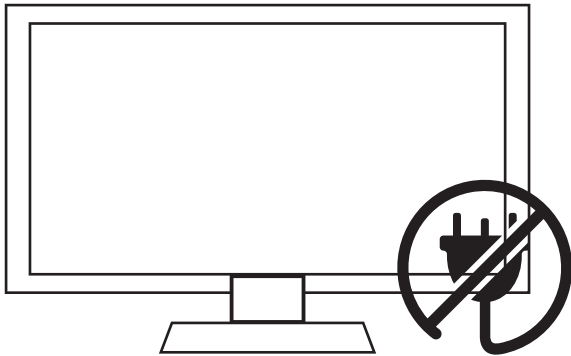

② Stand-up Output mode:While the power of TV and Media Player is off, insert one end of HDMI cable into HDMI OUT and insert the other end into HDMI IN port.

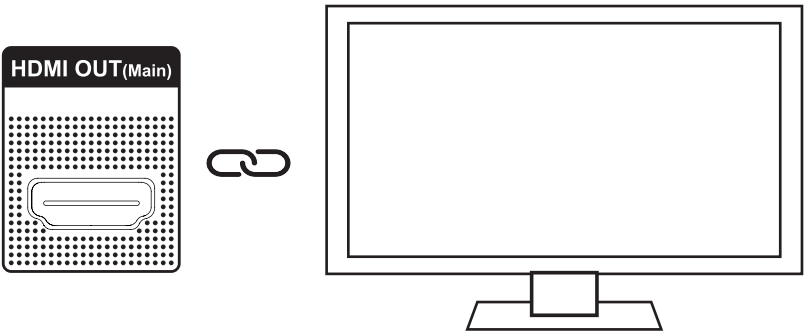

③ Double Output mode (audio and video separate output): please shutdown both TV and Media Player, then connect one HDMI cable from HDMI OUT AUDIO ONLY port to amplifier while connect the other HDMI cable from HDMI OUT MAIN port to TV.

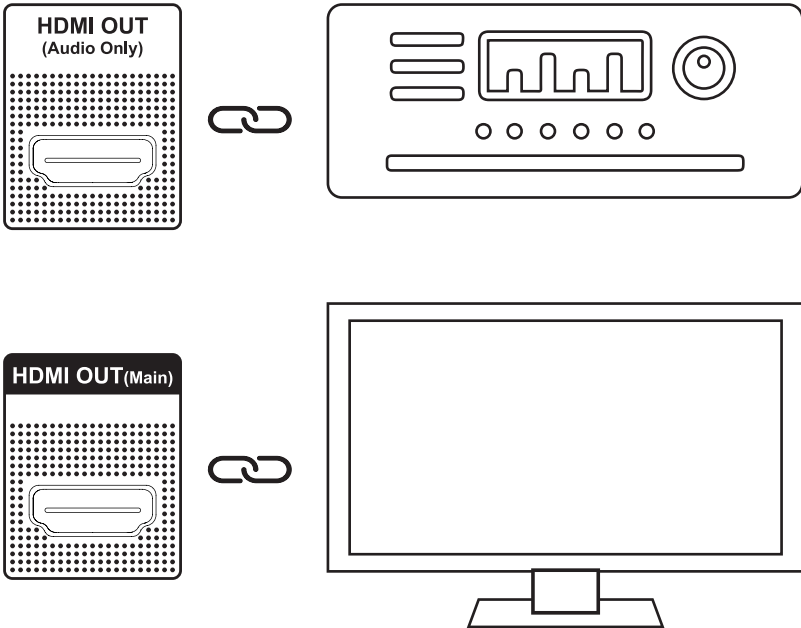

④ Connect with the power. This device is equipped with suitable AC power adapter. Please connect the head of AC power adapter to the AC power input port of this device, then insert the plug of AC power line into the alternating current socket of 110~120/220~240V.

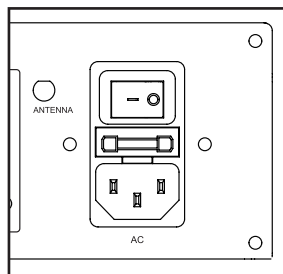

4K Hi-Fi MEDIA PAYER

⑤ Turn on device by pressing the power button on the right side of the front panel or pressing power button on remote control.

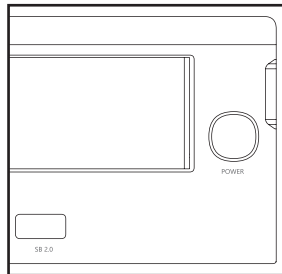

⑥ Corresponding video source is selected by TV.

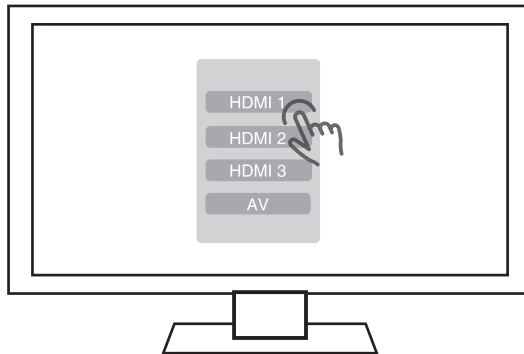

2.Connect AV cable with the TV

The connection method is same as that of HDMI cable. Please connect the AV cable before energizing.

Boot initialization wizard

Before using the machine formally, the system will perform the initial setup. Please set according to devices and requirements to get the best visual experience.

1. System language selection, screen zoom, time zone setting

Choose the system language according to your language habit.

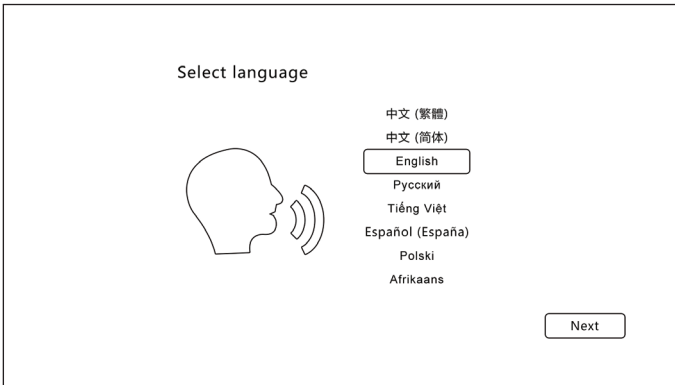

Press the UP and DOWN buttons on remote control to adjust screen display area.

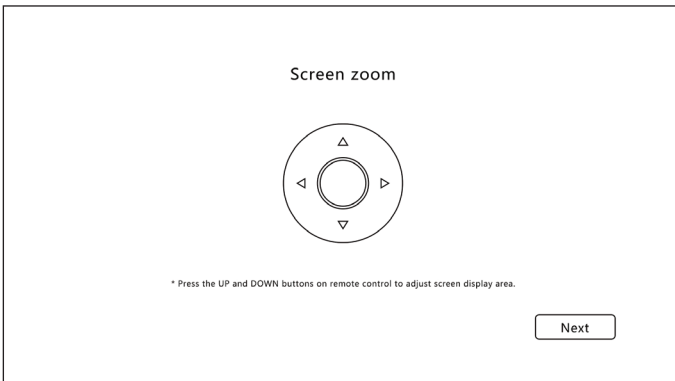

4K Hi-Fi MEDIA PAYER

Select the time zone for the system according to your location.



2. Bluetooth Match-Up

Let remote controller be aligned with media player and press Page-Down KEY and Menu KEY at the same time for least 5 second until indicator light blinking. The light will be off after matching successfully.

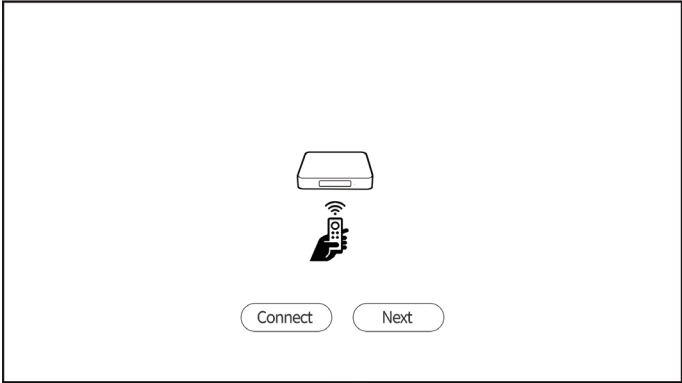

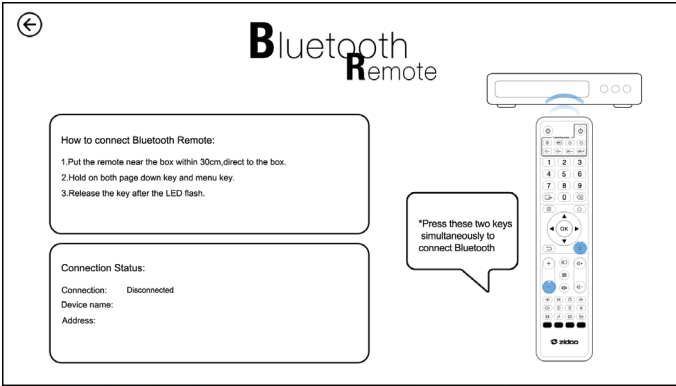

3. Network Setting

Configure network to connect device with network quickly.

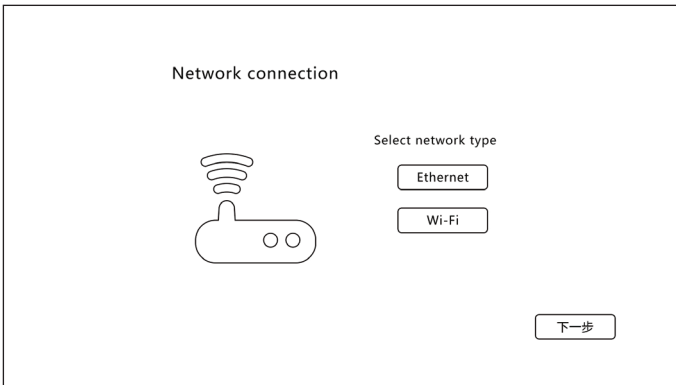

WiFi: choose network SSID, input password and connect WiFi.

Ethernet: plug in the network cable to connect the network automatically .

4. Select output mode

Please select the corresponding mode according to your needs, then it will finish relevant setting.

Wizard mode: select the corresponding option according to your usage environment and device connection.

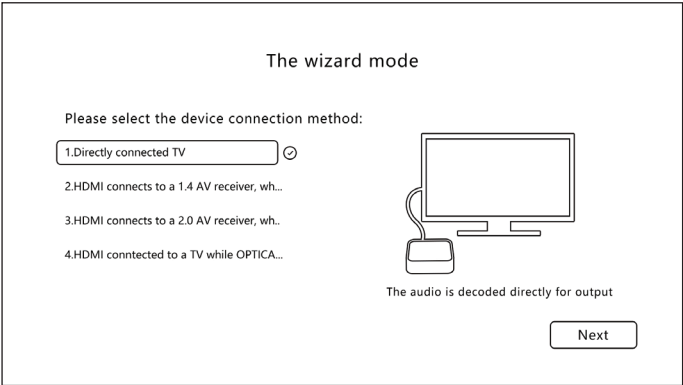

Expert mode: The audio and video output is customized by users, it is recommended for professionals.

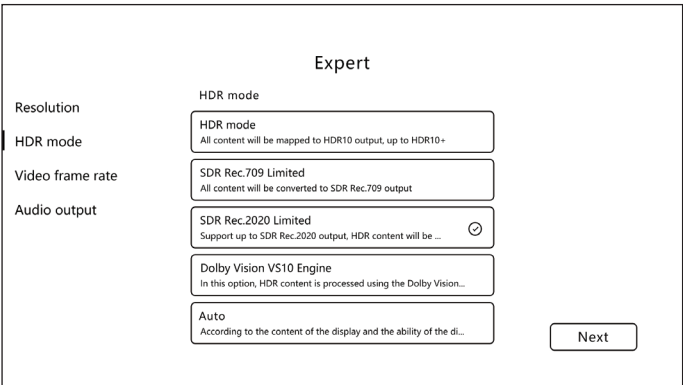

5. The key definition

Define the corresponding functions for number keys, timing key, subtitle key, audio key, up and down keys and page keys on the remote control according to your usage habits.

The key definition

Number keys	Specific percentage of video	>
Timing keys	Close	>
Subtitle keys	Subtitle list	>
Audio keys	Audio list	>
Up and Down keys	Switch chapter	>
Page Turning Keys	Switch chapter	>

After completing settings above, please follow prompts and click “Next” to finish initial setup. Enjoy Zidoo audio visual feast!

HDMI & DAC analog audio

1. Source In

It is needed to turn on Source In to connect speakers via analog XLR balance or RCA port.

Turning this switch on will be decoded by the XMOS output (DSD pass-through) to the DAC for highest native DSD 512 and PCM 768 high-sampling . There is no sound from HDMI and SPDIF when DAC Audio switch turns on.

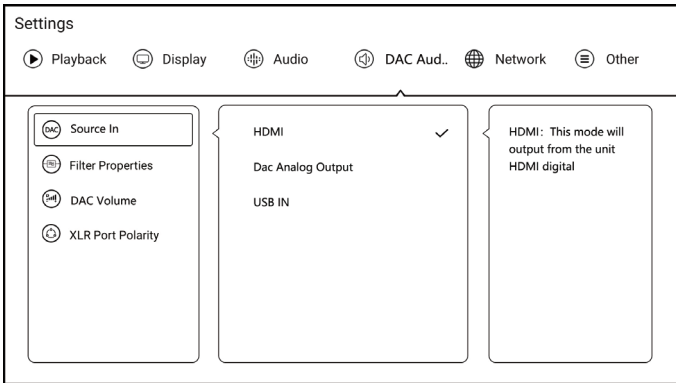

2. Filtering Features

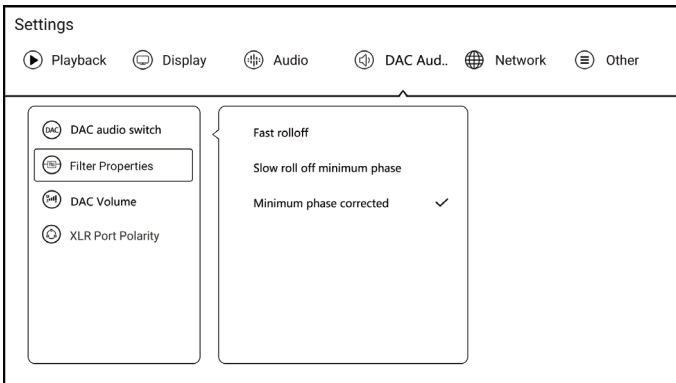

3. Analog Audio Volume

This setting is only for DAC decoder, audio value is DAC Decoder volume value.

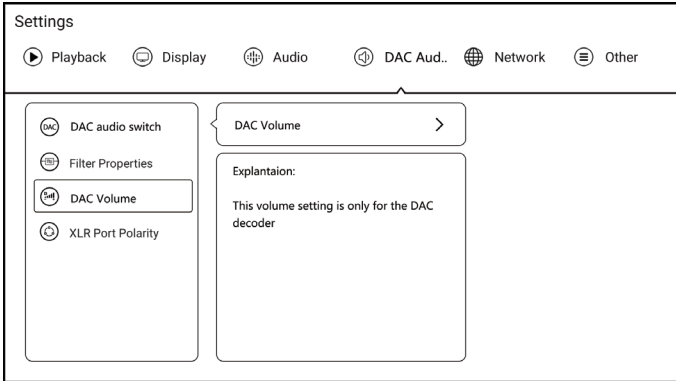

4. XLR Port polarity

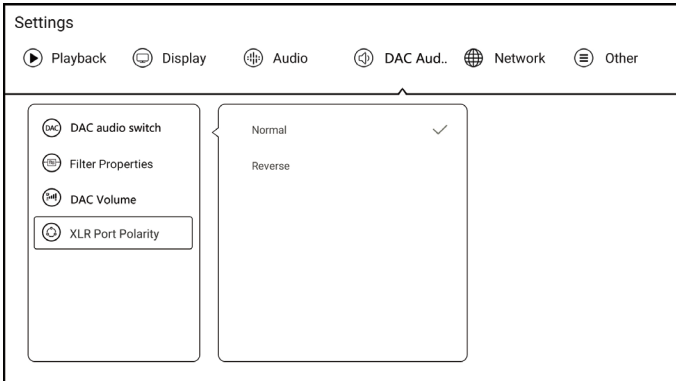

SYSTEM UPDATE BY OTA

Zidoo will update the firmware irregularly. Find the system update icon in APP center and open it; support online network update and local update; after ticking "automatically detect the latest version", you will receive the prompt for the latest firmware update automatically.

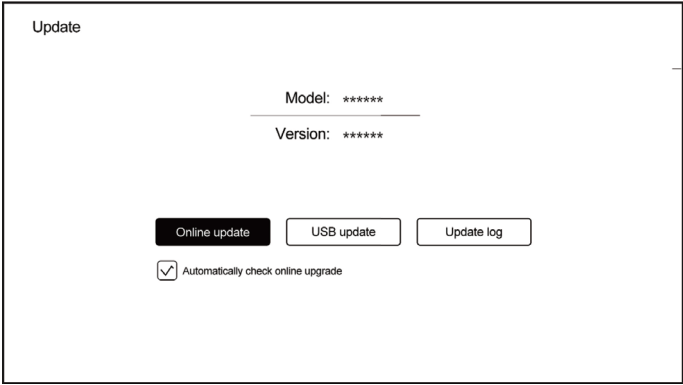

1. Online Update

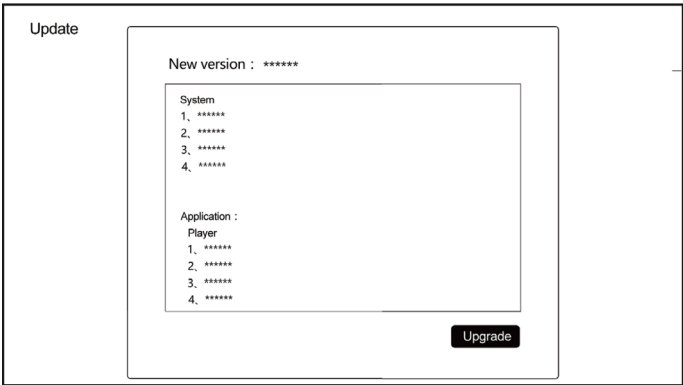

2. Local update

Users can download the update file on the forum or official website and update firmware by local update.

Copy the downloaded update file to USB disk. Click "local update" to select the update file.

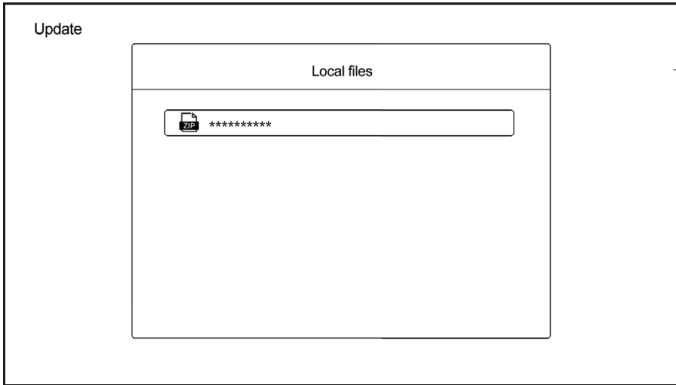

Download the update file by online update or local update. Click "update" to update.

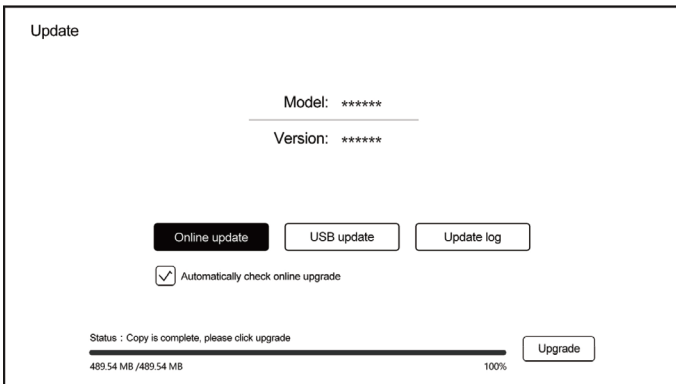

4K Hi-Fi MEDIA PAYER

The system will automatically check the update file whether is complete or not.

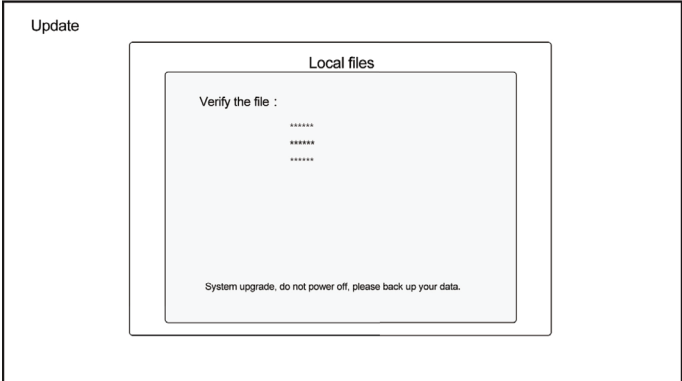

Note: System will upgrade automatically, please do not power off.

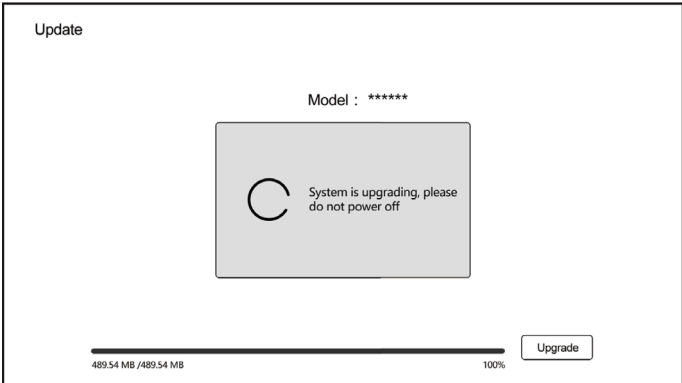

Once the update is completed, the system will automatically be restarted.



Special note:

To guarantee user experience, Zidoo will update the firmware irregularly. Therefore, this manual may not be totally in line with the product.

Warning notice:

- 1.The equipment shall not be subjected to water splashing or water drop, and shall not be placed on the device such as a vase, which is full of liquid.
- 2.The disconnecting device of this product is the power plug. The socket provided to this product should be installed near the product, and should be easy to operate and cannot be blocked by other objects.
- 3.This product is classified as **I** equipment, and it must have grounding measures inside the time box.

Guarantee

保修卡

User File

用户信息

User name 用户姓名		Sex 性别	
Address 回寄地址			
Telephone 联系电话		Zip 邮编	
Commodity name and specification 产品名称		Model NO. 型号	
Fault description 故障说明			

Guarantee Item

保修条款

- (1) One year guarantee from date of purchased. (not including fittings)
- (2) All of damage by man-made(tear open the housing,tear off the sticker,unnormally using),or losing this card,we will not guarantee.
- (1) 保修期限：本产品遵循国家三包条例，商品存在非人为损坏所引起的硬件故障，本公司将提供一年保修服务（配件除外）。
- (2) 如需寄回本公司维修，请与此保修卡一同寄回。
- (3) 一切人为因素造成的损坏（包括擅自拆机，撕毁标签，自行刷机等等），本公司将不予保修。



QUALIFIED
CERTIFICATE
合格证

CHECKER/检验员 _____

DATE/日期 _____

